

ENGLISH MEDIUM  
**RRB REASONING**  
**Chapterwise Solved Papers**

*Youth  
Competition  
Times*

**RAILWAY RECRUITMENT BOARD**

# RRB 2024

- Group D • NTPC Stage- I & II • ALP Stage- I & II
- RRB JE • Paramedical • RPF Constable/SI

# REASONING

**NEW**  
**TCS**  
PATTERN

**Up-to-Date  
Chapterwise**

**586  
Sets**

**Computer  
Based Test**

**Solved Papers**

**16180<sup>+</sup>**

Includes Chapterwise Presentation of  
Online Question Papers **(All Sets)** of RRB

**Objective  
Questions**

# RRRB

## General Intelligence

&

## Reasoning Test

(Computer Based Test)

## Chapterwise Solved Papers

**Chief Editor**

A.K. Mahajan

**Writers**

YCT Exam Expert Group

**Computer Graphics By**

Balkrishna Tripathi & Vinay Sahu

**Editorial Office**

12, Church Lane Prayagraj-211002

 **Mob. : 9415650134**

**Email : yctap12@gmail.com**

**website : [www.yctbooks.com](http://www.yctbooks.com)/ [www.yctfastbooks.com](http://www.yctfastbooks.com)**

**© All Rights Reserved with Publisher**

**Publisher Declaration**

Edited and Published by A.K. Mahajan for YCT Publications Pvt. Ltd.

and printed by Om Sai Offset. In order to Publish the book,

full care has been taken by the Editor and the Publisher,

still your suggestions and queries are welcomed.

**In the event of any dispute, the judicial area will be Prayagraj.**

**Rs. : 1195/-**



# Contents

■ Analysis chart of RRB Paramedical, JE, ALP, NTPC, Group-D, RPF SI & Constable Pre Exam Question Papers.....	5
■ RRB Paramedical, JE, ALP, NTPC, Group-D, RPF SI & Constable Papers Through Pie Chart and Bar Graph .....	6
<b>Section-1 : Analogy.....</b>	<b>7-64</b>
■ Type 1 : Analogy based on English/Hindi Words .....	7
■ Type 2 : Analogy based on English and Hindi Words given in the sentences.....	21
■ Type 3 : Analogy based on the English Alphabet.....	23
■ Type 4 : Analogy based on Numbers.....	34
■ Type 5 : Analogy based on Figures .....	54
■ Type 6 : Miscellaneous.....	60
<b>Section-2 : CODING-DECODING .....</b>	<b>65-117</b>
■ Type 1 : Problems based on codes in numbers of letters of the English alphabet .....	65
■ Type 2 : Problems based on coding of letters of the English alphabet in letters .....	76
■ Type 3 : Problems based on coding of word groups .....	97
■ Type 4 : Problems based on letter, number and symbols .....	108
■ Type 5 : Miscellaneous.....	114
<b>Section-3 : Classification .....</b>	<b>118-170</b>
■ Type 1 : Classification based on Words .....	118
■ Type 2 : Classification based on letters and symbols of the English Alphabet.....	128
■ Type 3 : Classification based on number/number pair.....	141
■ Type 4 : Classification based on shapes .....	144
■ Type 5 : Classification based on groups of figures .....	165
■ Type 6 : Miscellaneous.....	168
<b>Section-4 : Series .....</b>	<b>171-231</b>
■ Type 1 : Series based on numbers.....	171
■ Type 2 : Series based on letters .....	192
■ Type 3 : Mixed series of numbers and letters.....	202
■ Type 4 : Series based on figures .....	214
■ Type 5 : Miscellaneous.....	231
<b>Section-5 : Missing Number/Letter/Term/Figure .....</b>	<b>232-263</b>
■ Type 1 : Problems based on missing number .....	232
■ Type 2 : Problems based on missing letter.....	247
■ Type 3 : Problems based on missing figure.....	250
■ Type 4 : Miscellaneous.....	262

<b>Section-6 : Direction Test .....</b>	<b>264-318</b>
■ Type 1 : Problems based on direction in a particular situation of an individual .....	264
■ Type 2 : Problems based on direction in the particular situation of two persons .....	276
■ Type 3 : Problems based on finding the direction of one point with respect to another point.....	279
■ Type 4 : Problems based on Angle.....	286
■ Type 5 : Problems based on Distance .....	293
■ Type 6 : Mixed problems based on Distance and Direction .....	305
■ Type 7 : Problems based on Clockwise Direction .....	314
■ Type 8 : Miscellaneous.....	315
<b>Section-7 : Blood Relation .....</b>	<b>319-365</b>
■ Type 1 Relationship based on Hindi Names .....	319
■ Type 2 Problems based on Naming the Letters of the English Alphabet.....	343
■ Type 3 Miscellaneous.....	358
<b>Section-8 : Arithmetical Operations .....</b>	<b>366-406</b>
■ Type 1 : Arithmetical Operations based on the Conversion of Letters of the English Alphabet into Mathematical Symbols .....	366
■ Type 2 : Arithmetical Operations based on the Conversion of Mathematical Symbols into Mathematical Symbols.....	372
■ Type 3 : Arithmetical Operations based on the Conversion of Symbols into Mathematical Symbols .....	387
■ Type 4 : Arithmetical Operations based on Interchange of Digits/Numbers and Mathematical Symbols.....	391
■ Type 5 : Arithmetical Operations based on the Elimination of Mathematical Symbols.....	403
<b>Section-9 : Venn Diagram .....</b>	<b>407-436</b>
<b>Section-10 : Problems based on Diagram .....</b>	<b>437-459</b>
■ Type 1 : Diagram related problems based on letters and symbols of the English alphabet .....	437
■ Type 2 : Diagram related problems based on numbers.....	442
<b>Section-11 : Analytical Reasoning .....</b>	<b>460-512</b>
<b>Section-12 : Syllogism .....</b>	<b>513-605</b>
■ Type 1 : Syllogism based on the statement 'All' .....	513
■ Type 2 : Syllogism based on the statement 'Some' .....	533
■ Type 3 : Syllogism based on both 'Some' and 'All' statement.....	542
■ Type 4 : Syllogism based on both 'Some' and 'None' statement.....	581
■ Type 5 : Syllogism based on both 'All' and 'None' .....	585
■ Type 6 : Miscellaneous.....	596
<b>Section-13 : Statement and Conclusion.....</b>	<b>606-661</b>
■ Type 1 : General Statement and Conclusion .....	606
■ Type 2 : Statement and Conclusion based on Mathematical operations.....	640
■ Type 3 : Miscellaneous.....	655
<b>Section-14 : Statement and Assumption/Operations .....</b>	<b>662-695</b>
■ Type 1 : Problems based on statement and Assumption .....	662
■ Type 2 : Problems based on statement and Assumption .....	684
■ Type 3 : Problems based on statement and Assumption .....	688
■ Type 4 : Problems based on statement and Operation .....	692



<b>Section-15 : Data Sufficiency .....</b>	<b>696-723</b>
■ Type 1 : Data Sufficiency based on sequence.....	696
■ Type 2 : Data Sufficiency based on Mathematical operations .....	701
■ Type 3 : Data Sufficiency based on Codes .....	716
■ Type 4 : Data Sufficiency based on Blood relation.....	719
■ Type 5 : Problems based on Statement/Question and Reasoning/Statement .....	721
<b>Section-16 : Sequence and Sitting Arrangement.....</b>	<b>724-796</b>
■ Type 1 : Sequence arrangement based on row and alphabet.....	724
■ Type 2 : Sequence and Seating arrangement based on shapes like circular, square etc.....	750
■ Type 3 : Sequence arrangement based on series .....	774
■ Type 4 : Sequence arrangement based on height/length/weight etc .....	786
■ Type 5 : Sequence arrangement based on letters/words.....	795
<b>Section-17 : Calendar/Clock .....</b>	<b>797-823</b>
■ Type 1 : Problems based on Date and Day .....	797
■ Type 2 : Problems based on Year .....	808
■ Type 3 : Problems based on the angle between the hands of a clock.....	811
■ Type 4 : Problems based on Time.....	818
■ Type 5 : Miscellaneous.....	821
<b>Section-18 : Formation and Division of figure .....</b>	<b>824-843</b>
■ Type 1 : Problems based on figure formed by combining figures .....	824
■ Type 2 : Problems based on the shape formed by rotation and folding of figures .....	827
■ Type 3 : Problems based on the closest similarity of question figures.....	831
■ Type 4 : Problems based on built-in, in the option figures of the question figure.....	840
<b>Section-19 : Lines and Figures Counting.....</b>	<b>844-875</b>
■ Type 1 : Problems based on counting of Triangles .....	844
■ Type 2 : Problems based on counting of Quadrilaterals.....	862
■ Type 3 : Problems based on counting of Pentagons.....	862
■ Type 4 : Problems based on counting of Rectangles .....	863
■ Type 5 : Problems based on counting of Squares.....	864
■ Type 6 : Problems based on counting of Circles.....	872
■ Type 7 : Problems based on counting of Lines/Rows.....	873
<b>Section-20 : Water and Mirror Image .....</b>	<b>876-891</b>
■ Type 1 : Problems based on water image of figures.....	876
■ Type 2 : Problems based on mirror image of figures.....	879
■ Type 3 : Problems based on water and mirror image of letters, letter groups and words .....	887
■ Type 4 : Miscellaneous.....	891
<b>Section-21 : Cube/Cuboid/Dice .....</b>	<b>892-896</b>
<b>Section-22 : Miscellaneous.....</b>	<b>897-928</b>

## Analysis chart of Question Papers of Various Previous Exams of RRB

S.N.	Exams	Exam year	Total question paper	Total Questions of General Intelligence Test and Reasoning Test
1.	RRB NTPC 2019 Stage-2	2022	15	$15 \times 25 = 375$
2.	RRB Group-D 2019	2022	99	$99 \times 20 = 1980$
3.	RRB NTPC 2019 Stage-1	2020-21	133	$133 \times 30 = 3990$
4.	RPF Constable 2018	2019	17	$17 \times 35 = 595$
5.	RPF SI 2018	2019	23	$23 \times 35 = 805$
6.	RRB JE 2018	2019	38	$38 \times 25 = 950$
7.	RRB ALP 2018 Stage-2	2019	18	$18 \times 25 = 450$
8.	RRB Paramedical 2019	2019	6	$6 \times 5 = 30$
9.	RRB ALP/Tech. 2018 Stage-1	2018	30	$30 \times 25 = 750$
10.	RRB Group D 2018	2018	135	$135 \times 30 = 4050$
11.	RRB NTPC 2015 Stage-2	2017	9	$9 \times 35 = 315$
12.	RRB NTPC 2015 Stage-1	2016	63	$63 \times 30 = 1890$
		<b>Total</b>	<b>586</b>	<b>16,180</b>

**Note**— In this book, out of total **586** papers of JE, ALP, NTPC, RPF Constable, RPF SI, Group D and Paramedical exams conducted by RRB, out of total **16180** questions asked from General Intelligence Test and Reasoning Test. Some behavior have been removed and chapterwise compilation of questions of different types has been presented. In this book, every effort has been made by the Examination Special Committee to accommodate maximum variety of questions, so that the examinees can be made aware of the variety of questions asked by RRB.



# Trend Analysis of Previous Year RRB NTPC, Group-D, Paramedical, JE, ALP, RPF SI & Constable, Papers Through Pie Chart and Bar Graph

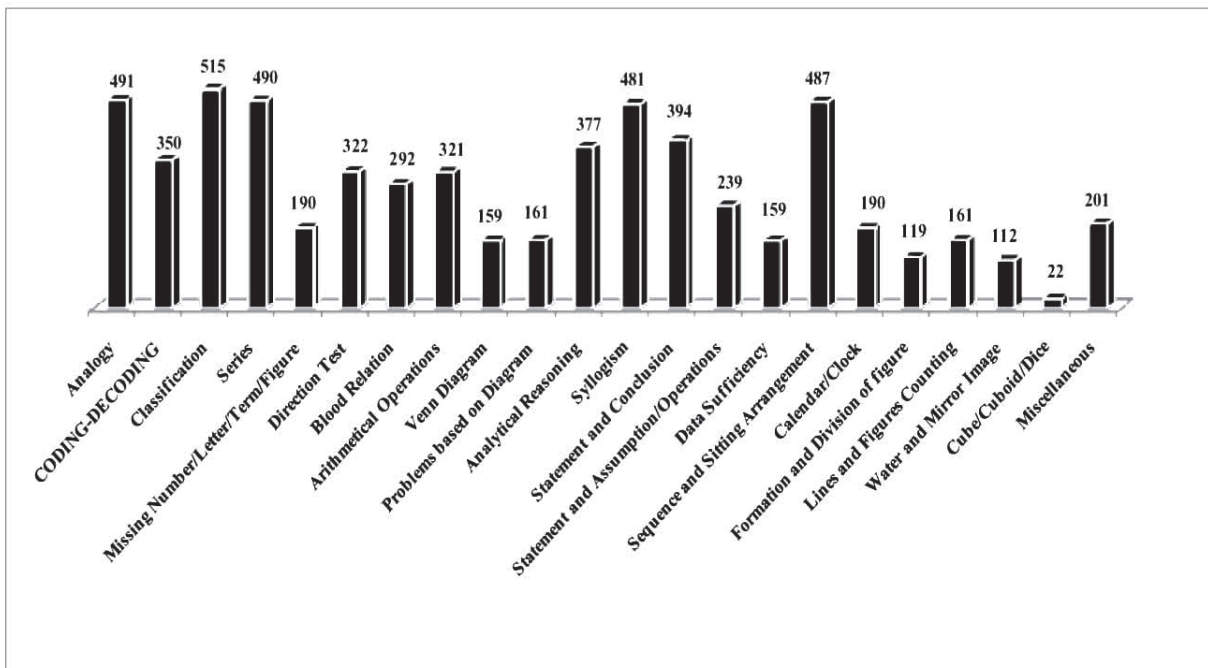
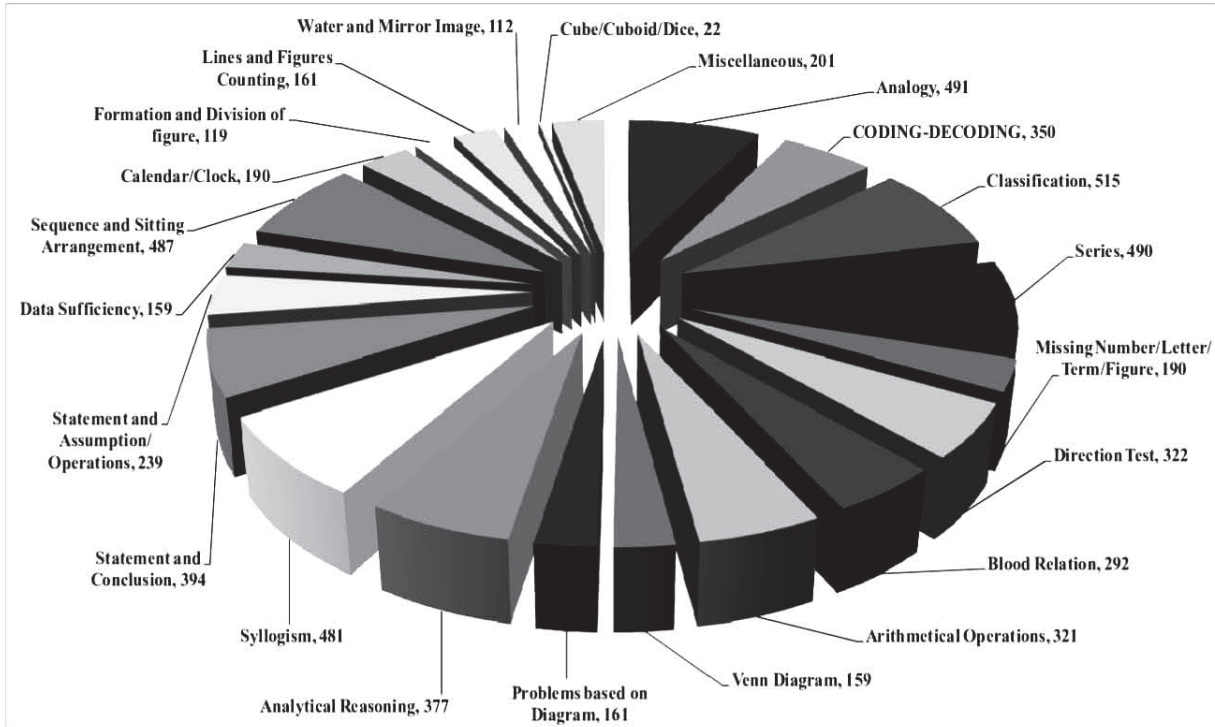

01.

join telegram channel-@studentsebook2

# Analogy

## Type - 1

1. Select the option that is related to the third term in the same way as the second term is related to the first term.

**Book : Reading :: Poetry : ?**

- (a) Rhyming (b) Singing  
(c) Recitation (d) Teaching

**RRB NTPC 19.01.2021 (Shift-I) Stage Ist**

**Ans. (c) :** Just as, book is read. Same as, poetry is read as recitation.

2. Select the option that is related to the third term in the same way as the second term is related to the first term.

**Pediatrics : Children :: Neurology : ?**

- (a) Veins (b) Eyes  
(c) Brain (d) Heart

**RRB NTPC 28.12.2020 (Shift-I) Stage Ist**

**Ans. (c) :** Just as, pediatrics is related to children. Similarly, neurology is related to brain.

3. In the following question, select the related words from the given alternatives.

**Writer : Pen :: Tailor : ?**

- (a) Axe (b) Needle  
(c) Saw (d) Scalpel

**RRB NTPC 28.12.2020 (Shift-I) Stage Ist**

**Ans. (b) :** Just as, the writer writes with pen. Same as, tailor stitches clothes with the needle.

4. Select the option that is related to the third word in the same way as the second word is related to the first word.

**Shirt : Apparel :: Necklace : ?**

- (a) Chain (b) Gold  
(c) Jewellery (d) Neck

**RRB NTPC 05.01.2021 (Shift-I) Stage Ist**

**Ans. (c) :** Just as, a Shirt is an Apparel. Similarly, a necklace is a 'Jewellery'.

5. Select the option that is related to the third word in the same way as the second word is related to the first word.

**Bihar : Jharkhand :: Chhattisgarh :**

- (a) Maharashtra (b) Ranchi  
(c) Raipur (d) Madhya Pradesh

**RRB NTPC 05.01.2021 (Shift-I) Stage Ist**

**Ans. (d) :** In the way the state of Jharkhand has been formed by dividing Bihar. Similarly, Chhattisgarh has been formed by dividing the state of Madhya Pradesh.

6. Select the option that is related to the third term in the same way as the second term is related to the first term?

**Gravity : Discovery :: Telephone : ?**

- (a) Experiment (b) Explore  
(c) Construct (d) Invention

**RRB NTPC 07.01.2021 (Shift-I) Stage Ist**

**Ans. (d) :** Just as, Newton discovered Gravity. Similarly, Telephone was invented by Graham Bell.

7. Select the option that is related to the third term in the same way as the second term is related to the first term?

**Happiness : Sorrow :: Conflict : ?**

- (a) Competition (b) Harmony  
(c) War (d) Anger

**RRB NTPC 07.01.2021 (Shift-I) Stage Ist**

**Ans. (b) :** Just as, opposite of Happiness is Sorrow, Similarly, opposite of Conflict is Harmony.

8. Select the option that is related to the third term in the same way as the second term is related to the first term.

**Paper : Stapler :: Clothes : ?**

- (a) Detergent (b) Dryer  
(c) Hanger (d) Washing machine

**RRB NTPC 08.01.2021 (Shift-II) Stage Ist**

**Ans. (c) :** The way of stapler is used to hang or punch the paper. Similarly, hanger are used to hang clothes.

9. Select the alternative which is related to the third word in the same way as the second word, is related to first word.

**Jaggery : Sugarcane :: Coconut : ?**

- (a) Beach (b) Fruit  
(c) Coconut hair (d) White

**RRB ALP CBT-2 Elec. - Mec. 21-01-2019 (Shift-II)**

**Ans. (c) :** Just as 'Jaggery' is obtained from 'Sugarcane', Similarly, 'Coconut hair' is obtained from 'Coconut'.

10. Select the option that is related to the third term in the same way as the second term is related to the first term.

**Hand : Thumb :: Pen : ?**

- (a) Finger (b) Holder  
(c) Paper (d) Nib

**RRB NTPC 08.01.2021 (Shift-II) Stage Ist**

**Ans. (d) :** Just as, thumb is a part of hand. Similarly, nib is a part of pen.



11. Select the option that is related to the third term in the same way as the second term is related to the first term.

India : Tiger :: Nepal : ?

- (a) Lion (b) Cow  
(c) Rhinoceros (d) Leopard

RRB NTPC 11.01.2021 (Shift-I) Stage Ist

Ans. (b) : Just as, Tiger is the National animal of India. Similarly, Cow is the National animal of Nepal.

12. Select the option that is related to the third term in the same way as the second term is related to the first term.

Patient : Doctor :: Student : ?

- (a) Monitor (b) School  
(c) Teacher (d) Lecture

RRB NTPC 12.01.2021 (Shift-I) Stage Ist

Ans. (c) : Just as, a sick person goes to the doctor for diagnosis. Similarly a student goes to the teacher to acquire knowledge.

13. Select the option that is related to the third term in the same way as the second term is related to the first term.

Serene : Calm :: fierce : ?

- (a) Proud (b) Cooler  
(c) Silent (d) Aggressive

RRB NTPC 17.01.2021 (Shift-I) Stage Ist

Ans. (d) : Just as, the synonym of Serene is Calm. Similarly, the synonym of Fierce is Aggressive.

14. Select the option that is related to the third term in the same way as the second term is related to the first term.

Nature : Inherent : Nurture : ?

- (a) Innate (b) Foster  
(c) Character (d) Trait

RRB NTPC 17.01.2021 (Shift-I) Stage Ist

Ans. (b) :

Adjective of Nature = Inherent and Adjective of Nurture = Foster

Hence in place of (?) will be Foster.

15. Select the option in which the words share the same relationship as that shared by the given pair of words. Writer : Pen

- (a) Swimmer : Float (b) Chef : Pan  
(c) Dancer : Program (d) Tailor : Dress

RRB NTPC 08.02.2021 (Shift-I) Stage Ist

Ans. (b) : Just as, Writer is related to Pen. Similarly, Chef is related Pan.

16. Select the option that is related to the third term in the same way as the second term is related to the first term?

RK Narayan : Novel : : RK Laxman : ?

- (a) Art (b) Comics  
(c) Advertising (d) Cartoon

RRB NTPC 09.02.2021 (Shift-I) Stage Ist

Ans. (d) : Just as, RK Narayan is related to the novel, in the same way RK Laxman is related to the cartoon.

17. Select the option that is related to the third term in the same way as the second term is related to the first term.

Nepal : Cow :: India : ?

- (a) Tiger (b) Lion  
(c) Peacock (d) Rhinoceros

RRB NTPC 09.02.2021 (Shift-I) Stage Ist

Ans. (a) : Just as, Cow is a national animal of Nepal. Same as, Tiger is a national animal of India.

18. Select the option in which the words share the same relationship as that shared by the given pair of words

Labrador : Dog ::

- (a) Individual : Mankind (b) Jazz : Music  
(c) Leaf : Tree (d) Mouse : Cat

RRB NTPC 05.03.2021 (Shift-I) Stage Ist

Ans. (b) : Just as, Labrador is a type of hunting dog which is found in abundance in Canada. Similarly, 'Jazz' is a genre of music in the United States.

19. Select the option that is related to the third term in the same way as the second term is related to the first term

Virus : Disease :: Exercise : ?

- (a) Cycling (b) Walking  
(c) Health (d) Jogging

RRB NTPC 04.01.2021 (Shift-II) Stage Ist

Ans. (c) : Just as, virus is cause of disease. Same as, exercise is cause of health.

20. Select the option that is related to the third term in the same way as the second term is related to the first term.

Himalayas : Ganga : : Satpura : ?

- (a) Kaveri (b) Narmada  
(c) Godavari (d) Yamuna

RRB NTPC 13.01.2021 (Shift-I) Stage Ist

Ans. (b) : Just as, the Ganga originates from the Himalayas. Similarly, the Narmada originates from the Satpura hills.

21. The option which is related to the third word. In the same way as the second word is related to the first word is -

Poem : Verse :: Book : ?

- (a) Story (b) Page  
(c) Printing (d) Language

RRB ALP CBT-2 Mec. - Diesel 23-01-2019 (Shift-I)

Ans. (b) : Just as Verse comes under Poem in the same way Page comes under Book.

22. Select the option which is similar to the third word. Just as the second word is related to the first word.

Paper : Gum : : Brick ?

- (a) Rajgir (b) Slurry  
(c) Stone (d) Wall

RRB ALP CBT-2 Electrician 23-01-2019 (Shift-II)



**Ans. (b) :** Such as Gum is used for sticking Paper similarly, Slurry is used for joining the Bricks.

23. Select the option that is related to the third term in the same way as the second term is related to the first term.

Assam : Tezpur :: Kerala : ?

- (a) Jaipur (b) Midnapore  
(c) Thenzawl (d) Kochi

RRB NTPC 16.01.2021 (Shift-II) Stage Ist

**Ans. (d) :** Just as, Tezpur is a district in Assam. Same as, Kochi is also a district in Kerala.

24. Select the option that is related to the third term in the same way as the second term is related to the first term.

Daman and Diu : Daman :: Andaman and Nicobar : ?

- (a) Nicobar (b) Indira Point  
(c) Garacharma (d) Port Blair

RRB NTPC 30.01.2021 (Shift-I) Stage Ist

**Ans. (d) :** Just as, Daman is the Capital of Daman and Diu. Similarly, the Capital of Andaman and Nicobar is Port Blair.

25. Select the option that is related to the third term in the same way as the second term is related to the first term.

Soldier: Battle Tank :: Farmer: ?

- (a) Water (b) Crop  
(c) Land (d) Tractor

RRB NTPC 03.03.2021 (Shift-II) Stage Ist

**Ans. (d) :** Just as, Battle tank is used for the help of Soldiers in Battle. Same as, Tractor is used for the help of Farmer in Agriculture.

26. Select the option in which the words share the same relationship as that shared by the given pair of words

Rhino : Horn

- (a) Elephant : Tusk (b) Cow : Calf  
(c) Dog : Bark (d) Donkey : Bray

RRB NTPC 05.03.2021 (Shift-II) Stage Ist

**Ans. (a) :** Just as, the rhinoceros has horns. Similarly, the elephant has tusk.

27. Select the option that is related to the third term in the same way as the second term is related to the first term.

Music : Concert :: Acting :

- (a) Song (b) Gymnastics  
(c) Dance (d) Theater

RRB NTPC 15.03.2021 (Shift-I) Stage Ist

**Ans. (d) :** Just as, music is presented in the concert in the same way acting is presented in the theater.

28. Select the option that is related to the third term in the same way as the second term is related to the first term.

Bed : Pillow :: Sofa : ?

- (a) Covers (b) Sheets  
(c) Upholstery (d) Cushions

RRB NTPC 15.03.2021 (Shift-I) Stage Ist

**Ans. (d) :** Just as, pillow is related to the bed in the same way cushions is related to the sofa.

29. Select the option that is related to the third term in the same way as the second term is related to the first term.

Sri Lanka : Island :: India.

- (a) Asia (b) Ocean  
(c) Peninsula (d) Plateau

RRB NTPC 01.04.2021 (Shift-I) Stage Ist

**Ans. (c) :** Just as, Sri Lanka is an Island country, in the same way India is a peninsula country.

30. Select the option that is related to the third term in the same way as the second term is related to the first term.

Fracture : Bone :: Sprain : ?

- (a) Ankle (b) Skin  
(c) Ligament (d) Tissue

RRB NTPC 08.04.2021 (Shift-I) Stage Ist

**Ans. (c) :** Just as, fracture occurs in bone. Same as, sprain occurs in ligament.

31. Select the option in which the words share the same relationship as that shared by the given pair of words.

Chef : Restaurant

- (a) Physician : Patient  
(b) Librarian : Catalogue  
(c) Carpenter : Wood  
(d) Druggist : Pharmacy

RRB NTPC 08.04.2021 (Shift-I) Stage Ist

**Ans. (d) :** Just as, a chef works in a restaurant. Similarly, a druggist works in a pharmacy.

32. Select the option that is related to the third term in the same way as the second term is related to the first term.

Mason : Builds :: Mechanic : ?

- (a) Cars (b) Tools  
(c) Factory (d) Repairs

RRB NTPC 23.07.2021 (Shift-II) Stage Ist

**Ans. (d) :** Just as, Mason builds home. Similarly, Mechanic repairs mechanical equipments.

33. Select the option that is related to the third term in the same way as the second term is related to the first term.

Dog : Guard :: Horse : ?

- (a) Cart (b) Saddle  
(c) Stable (d) Ride

RRB NTPC 28.12.2020 (Shift-II) Stage Ist

**Ans. (d) :** Just as, a dog is related to protect in the same way a horse is related to ride.

34. Select the option that is related to the third term in the same way as the second term is related to the first term.

Almirah : Storage :: Chair : ?

- (a) Keeping itmes (b) Lying down  
(c) Sitting (d) Standing

RRB NTPC 09.01.2021 (Shift-II) Stage Ist



**Ans. (c) :** Just as, Almirah is used for storage of item. Similarly, chair is used for sitting.

35. Select the option that is related to the third term in the same way as the second term is related to the first term.

**Import : Export :: Expenditure : ?**

- (a) Credit (b) Revenue  
(c) Budget (d) Economy

**RRB NTPC 13.01.2021 (Shift-II) Stage Ist**

**Ans. (b) :** Just as, imports are related to exports. Similarly, expenditure is related to revenue.

36. Select the option that is related to the third term in the same way as the second term is related to the first term.

**Ranthambore : Rajasthan :: Kaziranga : ?**

- (a) Assam (b) Nagaland  
(c) Meghalaya (d) Manipur

**RRB NTPC 19.01.2021 (Shift-II) Stage Ist**

**Ans. (a) :** Just as, Ranthambore is a national park of Rajasthan. Similarly, Kaziranga is a national park of Assam.

37. Select the option that is related to the third term in the same way as the second term is related to the first term.

**Gandhinagar : Ahmedabad :: Lucknow : ?**

- (a) Allahabad (b) Kanpur  
(c) Gorakhpur (d) Varanasi

**RRB NTPC 19.01.2021 (Shift-II) Stage Ist**

**Ans. (b) :** Just as, Gandhinagar and Ahmedabad are two major twin cities of Gujarat state. Similarly, Lucknow and Kanpur are two major twin cities of Uttar Pradesh.

38. Select the option that is related to the third term in the same way as the second term is related to the first term.

**Country : Coalition :: Worker : ?**

- (a) Labour (b) Skill  
(c) Union (d) Global

**RRB NTPC 01.03.2021 (Shift-I) Stage Ist**

**Ans. (c) :** Just as, there is a coalition in the country. Similarly, there is a union among the workers.

39. Select the option that is related to the third term in the same way as the second term is related to the first term.

**Author : Pen :: Surgeon : ?**

- (a) Cut (b) Scalpel  
(c) Stitch (d) Operation

**RRB NTPC 14.03.2021 (Shift-II) Stage Ist**

**Ans. (b) :** Just as, a Author write with a pen. Similarly surgeons use a scalpel for operation.

40. Select the option in which the words share the same relationship as that shared by the given pair of words.

**Cube : Square**

- (a) Rectangle : Rhombus (b) Cone : Hat  
(c) Sphere : Circle (d) Area : Perimeter

**RRB NTPC 09.03.2021 (Shift-II) Stage Ist**

**Ans. (c) :** Just as, Cube is three dimensional and Square is two-dimensional.

Same as, Sphere is three dimensional and Circle is two-dimensional .

41. Select the option that is related to the third term in the same way as the second term is related to the first term.

**Bricks : Kiln :: Coins :**

- (a) Laboratory (b) Mine  
(c) Mint (d) Factory

**RRB NTPC 03.04.2021 (Shift-I) Stage Ist**

**Ans. (c) :** Just as, bricks are made in a kiln. Similarly, coins are minted in the mint.

42. Select the option that is related to the third term in the same way as the second term is related to the first term.

**Microscope : Telescope :: Magnifying Glass : ?**

- (a) Binoculars (b) Kaleidoscope  
(c) Camera (d) Projector

**RRB NTPC 31.07.2021 (Shift-II) Stage Ist**

**Ans. (a) :** Just as, 'Microscope' is used to see a near object and 'Telescope' is used to see a distant object. Similarly, 'Magnifying glass' are used to see a near object and 'Binoculars' are used to see a distant object.

43. Select the option that is related to the third term in the same way as the second term is related to the first term.

**Aircraft : Cabin :: Train : ?**

- (a) Platform (b) Track  
(c) Engine (d) Coach

**RRB NTPC 31.07.2021 (Shift-II) Stage Ist**

**Ans. (d) :** Just as, 'aircraft' has a cabin to sit in. Similarly, a 'train' has a coach to sit on.

44. Select the option that is related to the third term in the same way as the second term is related to the first term.

**Day : Week :: Month : ?**

- (a) Calendar (b) Annual  
(c) Weeks (d) Year

**RRB NTPC 22.01.2021 (Shift-I) Stage Ist**

**Ans. (d) :** Just as, there are 7 days in a week. Similarly, there are 12 month in a year. Hence, option (d) will be correct answer.

45. Select the option that is related to the third term in the same ways as the second term is related to the first term.

**Navy : Ship :: Army : ?**

- (a) Guns (b) Tanks  
(c) Soldier (d) War

**RRB NTPC 22.01.2021 (Shift-I) Stage Ist**

**Ans. (b) :** Just as, a ship (water ship) is used in the Navy similarly a tank is used in the Army.

46. Select the word pair that shares a similar relationship as the word pair shown below.

**Word : Book**

- (a) Song : Music (b) Leaf : Tree  
(c) Sweet : Sugar (d) Sleep : Bed

**RRB NTPC 22.01.2021 (Shift-II) Stage Ist**

**Ans. (b) :** Just as, Book has many number of Words. Similarly, Tree has many number of leaves. Hence, option (b) is right.



47. Select the option in which the words do NOT share the same relationship as that shared by the given group of words.

**Patient : Surgeon : Surgery**

- (a) Vegetables : Chef : Cook  
(b) Chalk : Teacher : Students  
(c) Cloth : Tailor : Stitch  
(d) Clay : Potter : Pottery

**RRB NTPC 27.01.2021 (Shift-II) Stage Ist**

**Ans. (b) :** Chalk, the relationship between teacher and student is not the same as between the words of the given group.

Hence, option (b) is correct.

48. Select the option that is related to the third term in the same way as the second term is related to the first term.

**Boxing : Round :: Badminton : ?**

- (a) Point (b) Tournament  
(c) Match (d) Game

**RRB NTPC 29.01.2021 (Shift-II) Stage Ist**

**Ans. (d) :** Just as, boxing is related to the round, in the same way badminton will be related to game.

49. Select the option that is related to the third term in the same way as the second term is related to the first term.

**Law : Order :: Crime : ?**

- (a) War (b) Punishment  
(c) Peace (d) Criminal

**RRB NTPC 01.02.2021 (Shift-II) Stage Ist**

**Ans. (b) :** Just as, order is related to law. Similarly, punishment is related to crime.

50. Select the option that is related to the third term in the same way as the second term is related to the first term.

**Clock : Time :: Thermometer : ?**

- (a) Temperature (b) Fever  
(c) Illness (d) Weather

**RRB NTPC 03.02.2021 (Shift-II) Stage Ist**

**Ans. (a) :** Just as, the time is displayed by clock in the same way temperature is displayed by thermometer.

51. Select the option that is related to the third term in the same way as the second term is related to the first term.

**Tongue : Taste :: Lungs : ?**

- (a) Respiration (b) Perspiration  
(c) Cognition (d) Circulation

**RRB NTPC 03.02.2021 (Shift-II) Stage Ist**

**Ans. (a) :** Just as, taste is taken by the tongue. In the same way the respiration takes place through the lungs.

52. Select the option in which the words share the same relationship as that shared by the given pair of words.

**Photosynthesis = Sun Light**

- (a) Writing = Pen (b) Book = Magazine  
(c) Printer = Deskjet (d) Fan = Light

**RRB NTPC 03.02.2021 (Shift-II) Stage Ist**

**Ans. (a) :** Just as, 'Sunlight' is needed for 'Photosynthesis'. Similarly, 'Pen' is needed for 'Writing'. Hence, the option (a) is correct.

53. Select the option that related to the third term in the same way as the second term is related to the first term.

**Steps : Staircase :: Book : ?**

- (a) Library (b) Stories  
(c) Novels (d) Authors

**RRB NTPC 12.02.2021 (Shift-I) Stage Ist**

**Ans. (a) :** Just as, staircase contains steps. Same as, books placed in library.

54. Select the option that is related to the third term in the same as the second term is related to the first term.

**Bees : Honey :: Flowers : ?**

- (a) Petals (b) Fruit  
(c) Fragrance (d) Plant

**RRB NTPC 12.02.2021 (Shift-I) Stage Ist**

**Ans. (c) :** Just as, Honey bring out from flower by bees. Same as, flowers emits fragrance.

55. Select the option in which the words do NOT share the same relationship as that shared by the rest.

- (a) Parrot : Bird (b) Carrot : Vegetable  
(c) Car : Vehicle (d) Fruit : Tree

**RRB NTPC 22.02.2021 (Shift-II) Stage Ist**

**Ans. (d) :** Just as, parrot comes under Birds category, carrot comes under Vegetables category, car comes under vehicle category. Whereas, fruits does not comes under the tree category. So, it is different from other.

56. Select the option that is related to the third term in the same way as the second term is related to the first term.

**Beauty : See :: Melody : ?**

- (a) Touch (b) Hear  
(c) Sense (d) Feel

**RRB NTPC 27.02.2021 (Shift-II) Stage Ist**

**Ans. (b) :** Just as, 'Beauty' is related to 'See'. Similarly, 'Melody' is related to 'Hear'.

57. Select the option that is related to the third term in the same way as the second term is related to the first term.

**Giraffe : Height :: Tiger : ?**

- (a) Claws (b) Whisker  
(c) Stripe (d) Hunter

**RRB NTPC 09.03.2021 (Shift-I) Stage Ist**

**Ans. (c) :** Just as, Giraffe is highest in animal which is known for his height and length of neck. Same as, stripes are found in body of Tigers.

58. Select the option that is related to the third term in the same way as the second term is related to the first term.

**Wallet : Money :: Pendrive : ?**

- (a) Storage (b) Pocket  
(c) Data (d) Computer

**RRB NTPC 15.03.2021 (Shift-II) Stage Ist**



**Ans. (c) :** Just as, 'Wallet' is related to 'Money'. Similarly, Pen drive is related to Data.

59. Select the option that is related to the third term in the same way as the second term is related to the first term.

**Laboratory : Manual :: Library : ?**

- (a) Book - shelf (b) Catalogue  
(c) Librarian (d) Books

**RRB NTPC 21.03.2021 (Shift-II) Stage Ist**

**Ans. (b) :** Just as, Laboratory has a manual in which explained the instruction of Laboratory. Same as, there is a catalogue in library.

60. Select the option that is related to the third word on the same basis as the second word is related to the first word?

**Skin : Hair :: Land : ?**

- (a) Ore (b) Dust  
(c) Grass (d) Mineral

**RRB Group-D – 19/09/2018 (Shift-III)**

**Ans. (c) :** Just as, hair is produced from the skin. Same as, grass is produced from the land.

61. Select the option that is related to the third word on the same basis as the second word is related to the first word.

**Needle : Stitches :: Knife :**

- (a) Blade (b) Butter  
(c) Cut (d) Sharp

**RRB Group-D – 25/09/2018 (Shift-III)**

**Ans. (c) :** Just as, needle is used for stitching. Same as, knife is used for cutting.

62. Select the option that is related to the third word on the same basis as the second word is related to the first word.

**Petrol : Van :: Electricity : ?**

- (a) Goods (b) Bulb  
(c) Dark (d) Class

**RRB Group-D – 16/10/2018 (Shift-II)**

**Ans. (b) :** Just as, van runs from petrol. Same as, the light of bulb glows from electricity.

63. Select the option that is related to the third word on the same basis as the second word is related to the first word.

**Green : colour :: Apple : \_\_\_\_\_**

- (a) Fruit (b) Sweet  
(c) Sphere (d) Red

**RRB Group-D – 30/10/2018 (Shift-III)**

**Ans. (a) :** Just as, green comes under colour. Similarly, apple comes under fruit.

64. Select the option that is related to the third word on the same basis as the second word is related to the first word.

**Work : Try :: Sleep : ?**

- (a) Wake up (b) Freedom  
(c) Rest (d) Near

**RRB Group-D – 31/10/2018 (Shift-I)**

**Ans. (c) :** Just as, try is related to work. Same as, rest is related to sleep.

65. Find the similar pair.

**Ball : Throw :: \_\_\_\_\_ : \_\_\_\_\_**

- (a) Doge : To Pat (b) Hockey : Ball  
(c) Ball : Bat (d) Football : Kick

**RRB Group-D – 05/12/2018 (Shift-II)**

**Ans. (d) :** Just as, ball is played by throw. Same as, football is played by kick.

66. Select the option that is related to the third word on the same basis as the second word is related to the first word.

**Poet : Poem :: Cobbler : ?**

- (a) Meat (b) Shoes  
(c) Socks (d) Cloths

**RRB Group-D – 05/12/2018 (Shift-III)**

**Ans. (b) :** Just as, poet writes poem. Same as, cobbler stitches/mends shoes.

67. Select the option that is related to the third word on the same basis as the second word is related to the first word.

**Iron : Fe :: Silver : ?**

- (a) Na (b) Cl  
(c) Ag (d) K

**RRB Group-D – 04/12/2018 (Shift-III)**

**Ans. (c) :** Just as, Iron's symbol is 'Fe'. Same as, Silver's symbol is 'Ag'

68. Select the option that is related to the first word on the same basis as the fourth word is related to the third word.

**Monarch : \_\_\_\_\_ :: Anaconda : Cobra**

- (a) Butterfly (b) Queen  
(c) Royal (d) Venam

**RRB Group-D – 03/12/2018 (Shift-II)**

**Ans. (b) :** Just as, Anaconda is related to Cobra. Same as, Monarch is related to Queen.

69. Select the option that is related to the third word on the same basis as the second word is related to the first word.

**Shadow : Light :: Reflection : ?**

- (a) Cloth (b) Dirt  
(c) Water (d) Air

**RRB Group-D – 01/12/2018 (Shift-II)**

**Ans. (c) :** Just as, the phenomenon of shadow make in light. Same as, the phenomenon of reflection make in water.

70. Select the option that is related to the third word on the same basis as the second word is related to the first word.

**Chemistry : Atom :: Biology : ?**

- (a) Atom (b) Neuron  
(c) Biometrics (d) Cells

**RRB Paramedical 20.07.2019 Shift : I**

**Ans. (d) :** Just as, 'Atom' is the smallest unit of Chemistry. Same as, 'Cells' is the smallest unit of Biology.

71. Select the option that is related to the third word on the same basis as the first word is related to the second word.

Earth : Blue :: Mars : \_\_\_\_\_ ?

- (a) Black (b) Red  
(c) Green (d) Brown

RRB Group-D – 16/11/2018 (Shift-III)

Ans. (b) : Just as, Earth is called blue planet. Same as, Mars is called red planet.

72. Select the option that is related to the third word on the same basis as the second word is related to the first word.

Stage : Entertainment :: Temple : ?

- (a) People (b) God  
(c) Live (d) Worship

RRB Group-D – 05/11/2018 (Shift-II)

Ans. : (d) The way entertainment is related to stage. Same as, worship is related to temple.

73. Select the pair from given alternative that are related like the words of the first pair.

Uncouth : Civilized : ..... : .....

- (a) Ruthless : Brave (b) Wild : Animal  
(c) Dark : Light (d) Illiterate : Book

RRB NTPC 12.04.2016 Shift : III

Ans. (c) : Just as, the word uncouth is the opposite of civilized. Same as, dark is the opposite of light.

74. Select the pair from given alternative that are related like the words of the first pair

Mountain : Height : ..... : .....

- (a) River : Water (b) Cave : Depth  
(c) Valley : Beauty (d) Moon : Shadow

RRB NTPC 16.04.2016 Shift : II

Ans. (b) : Just as, mountain is known for its height. Same as, cave is known for its depth.

75. Find the right option for Smile : Laugh :: Cry : ?

- (a) Frown : Anger : Fury  
(b) Touch : Catch : Leave  
(c) Stand : Sleep : Play  
(d) Evening : Night : Day

RRB NTPC 16.04.2016 Shift : II

Ans. (b) : The word in question bears resemblance to the group-Touch : Catch : Leave

76. Select the pair from given alternative that are related like the words of the first pair

Chalk : Blackboard : ..... : .....

- (a) Door : Handle (b) Ink : Paper  
(c) Type : Paint (d) Table : Chair

RRB NTPC 18.04.2016 Shift : III

Ans. (b) Just as, chalk is required to write on the black board. Same as, ink is required to write on the paper.

77. Based on the analogy given, find the missing word from the given options?

Mother : Child : : Cloud : ?

- (a) Rain (b) Thunder  
(c) Water (d) Weather

RRB NTPC 18.04.2016 Shift : I

Ans. (a) : Just as, the child is born from mother, .Same as,rain originates from cloud.

78. Complete the analogy by choosing most appropriate option.

Bird : Wings :: Fish : ?

- (a) Gills (b) Head  
(c) Fins (d) Legs

RRB NTPC 19.04.2016 Shift : I

Ans. (c) : The way a bird flies in the sky with wings. Similarly, a fish swims in the water with fins.

79. Complete the analogy by choosing most appropriate option.

Hard : Stone :: Soft : ?

- (a) Feathers (b) Shine  
(c) Moon (d) Sand

RRB NTPC 18.01.2017 Shift : II

Ans. (a) : Just as, hard is related with stone. Same as, soft is related with feathers.

80. Complete the analogy by choosing most appropriate option.

Book : Author :: Furniture ?

- (a) Machine (b) Woodcutter  
(c) Wood (d) Carpenter

RRB NTPC 18.01.2017 Shift : II

Ans. (d) : Just as, an author writes book. Same as, carpenter makes furniture.

81. Complete the analogy by choosing most appropriate option.

Tide ebb : Sea :: ? : River

- (a) Dam (b) Hydroelectric  
(c) Bank (d) Inflow

RPF Constable 24.07.2019 Shift : II

Ans. (d) : Just as, tide ebb is related to sea. Same as, inflow is related to river.

82. Complete the analogy by choosing most appropriate option.

Rice : Carbohydrate :: Sprouted grains : ?

- (a) Water (b) Protein  
(c) Heat (d) Fat

RRB NTPC 18.01.2017 Shift : I

Ans. (b) : The way carbohydrate is found in rice, in the same way protein is found in sprouted grains.

83. Select the alternative that shows a similar relationship as the given pair.

Minimum : Maximum

- (a) Worst : Best (b) Happy : Gay  
(c) First : Second (d) Sad : Angry

RRB NTPC 30.03.2016 Shift : I

Ans. (a) : Just as, minimum is the opposite of maximum. Same as, worst is the opposite of best.

84. Choose the pair which is related in the same way as the word in the first pair from the given choice.

India : Tiger :: America : .....

- (a) Unicorn (b) Bald Eagle  
(c) Turul (d) Druk

RRB NTPC 02.04.2016 Shift : III

Ans. (b) : Just as, Tiger is the national animal of India. Same as, Bald Eagle is the national animal of America.

85. Choose the pair which is related in the same way as the word in the first pair from the given choice

India : Rupee :: South Africa :



- (a) Dollar (b) Rand  
(c) Pound (d) Franc

**RRB NTPC 04.04.2016 Shift : III**

**Ans. (b) :** Just as, India's currency is Rupee. Same as, South Africa's currency is Rand.

- 86. Choose the pair which is related in the same way as the word in the first pair from the given choice.**

**Water : Sea :: Ice : ?**

- (a) Mountain (b) Glacier  
(c) Hail (d) Peak

**RRB NTPC 17.01.2017 Shift-III**

**Ans. (b) :** Just as, the sea is filled with water. Similarly, the glacier is covered with ice.

- 87. Choose the pair which is related in the same way as the word in the first pair from the given choice**

**Sparrow : Grain :: Silk worm : ?**

- (a) Maple (b) Pine  
(c) Mulberry (d) Silk

**RRB NTPC 17.01.2017 Shift-III**

**Ans. (c) :** Just as, Sparrow's diet is grain. Similarly, diet of silk worm is mulberry.

- 88. Select the right pair from available option:**

**Eye : Tears :: ..... : .....**

- (a) Sea : Water (b) Volcano : Lava  
(c) Heart : Arteries (d) Hungry : Bread

**RRB NTPC 17.01.2017 Shift- III**

**Ans. (b) :** The way tears come out of the eye. Same as, lava comes out of the volcano.

- 89. Select the right pair from available option:**

**Heat : Cold :: ..... : .....**

- (a) Vast : Big (b) Thin : Thick  
(c) Long : High (d) Male : Baby

**RRB NTPC 17.01.2017 Shift- III**

**Ans. (b) :** Just as, heat is the opposite of cold. Same as, thin is the opposite of thick.

- 90. Complete the analogy**

**Grief : Happiness : Diffidence**

- (a) Ignorance (b) Sorrow  
(c) Confidence (d) Funky

**RRB NTPC 17.01.2017 Shift- II**

**Ans. (c) :** Just as, Grief is the opposite of happiness. Same as, diffidence is the opposite of confidence.

- 91. Select the option that is related to the third term in the same way as the second term is related to the first term:**

**Work : Joule :: Power : .....**

- (a) Ohm (b) Volt  
(c) Watt (d) Power

**RRB ALP & Tec. (17-08-18 Shift-III)**

**Ans. (c) :** Just as, work's unit is Joule. Same as, unit of Power is Watt.

- 92. Select the related word from the given alternatives:**

**Transport : Goods :: Bank :**

- (a) Money (b) Rupees  
(c) Pound (d) Dollar

**RRB ALP & Tec. (14-08-18 Shift-I)**

**Ans. (a) :** Just as, Goods carried by transport. Same as, money is exchanged with a bank. Therefore the bank is related with money.

- 93. Select the word pair that is analogous to the given word pair.**

**Sankranti : Andhra Pradesh**

- (a) Onam : Kerala  
(b) Bhangra : Punjab  
(c) Christmas : Christians  
(d) Kathak : Uttar Pradesh

**RRB ALP & Tec. (29-08-18 Shift-I)**

**Ans. (a) :** Just as, Sankranti festival is celebrated in Andhra Pradesh. Same as, Onam festival is celebrated in Kerala.

- 94. Select the related word from the given alternatives :**

**Wheel : Spokes :: Fan :**

- (a) Round (b) Air  
(c) Wings (d) Motor

**RRB ALP & Tec. (13-08-18 Shift-I)**

**Ans. (c) :** Just as, spokes is related to wheel. Similarly, wings is related to fan.

- 95. Select the related word pair from the following options.**

**Goose : Geese ::**

- (a) Socks : Sock (b) Shirts : Shirt  
(c) Jacket : Jacket (d) Pant : Pants

**RRB ALP & Tec. (09-08-18 Shift-I)**

**Ans. (d) :** Just as, plural of goose is geese. Same as, plural of pant is pants.

- 96. Choose the correct analogous word pair from the given alternatives.**

**Carpenter : Hammer**

- (a) Crane : Builder (b) Computer : Writer  
(c) Plumber : Wrench (d) Axe : Logger

**RRB ALP & Tec. (09-08-18 Shift-II)**

**Ans. (c) :** Just as, carpenter's main tool is hammer. Same as, main tool of plumber is wrench.

- 97. Which word would best complete the relation given below ?**

**Hotel : Menu :: Library : ?**

- (a) Librarian (b) Book  
(c) Shelf (d) Catalogue

**RRB JE - 27/06/2019 (Shift-III)**

**Ans. (d) :** Just as, a hotel has a menu. Same as, there are catalogue in the library.

- 98. Which word would best complete the relation given below**

**Grain : Pile :: Paper : ?**

- (a) Storage (b) Pile  
(c) Bundle (d) Filament

**RPF SI 16.01.2019 Shift : I**

**Ans. (c) :** Just as, Grains is related to pile. Same as, papers will related to the bundle.

- 99. Which word would best complete the relation given below ?**

**Light : Blind :: Speech : ?**

- (a) Dumb (b) Language  
(c) Tongue (d) Sound

**RRB JE - 26/06/2019 (Shift-III)**

**Ans. (a) :** Just as, light is related to blind. Same as, speech is related to dumb.

- 100. Which word would right way complete the relation given below ?**

**Japan : Green pheasant :: India : ?**

- (a) Parrot (b) Emu  
(c) Peacock (d) Sparrow

**RRB JE - 24/05/2019 (Shift-I)**



**Ans. (c) :** Just as, the national bird of Japan is 'Green pheasant. Same as, the national bird of India is 'Peacock'.

**101. Which word would right way complete the relation given below ?**

**Hygrometer : Humidity :: Barometer : ?**

- (a) Motion (b) Pressure  
(c) Temperature (d) Current

**RRB JE - 24/05/2019 (Shift-I)**

**Ans. (b) :** Just as, hygrometer is an instrument for measuring humidity. Same as, barometer is an instrument for measuring pressure.

**102. Select the word pair that represents the same relation as the pair below.**

**Cholera : Water**

- (a) Malaria : Mosquito (b) Cat : Plague  
(c) Poison : Death (d) Medicine : Disease

**RRB JE - 24/05/2019 (Shift-III)**

**Ans. (a) :** Just as, cholera is a water borne disease. Same as, malaria is a mosquito borne disease.

**103. Which word would best complete the relation given below ?**

**Mountain : Valley :: Enemy : ?**

- (a) Unknown (b) Ruthless  
(c) Friend (d) Country

**RPF SI 13.01.2019 Shift : II**

**Ans. (c) :** Just as, mountain is the opposite of valley. Same as, enemy is the opposite of friend.

**104. Which word would best complete the relation given below**

**Face : Expression :: Hand : ?**

- (a) Handshake (b) Indication  
(c) Painting (d) Work

**RRB JE - 02/06/2019 (Shift-I)**

**Ans. (b) :** Just as, expression is related to face. Same as, indication is related to hand.

**105. Which word would best complete the relation given below ?**

**Cube : Square :: Square : ?**

- (a) Triangle (b) Line  
(c) Arc (d) Point

**RRB JE - 02/06/2019 (Shift-II)**

**Ans. (b)** Just as, Cube is make of combination of squares. Same as, square is made of combination of lines.

**106. Which word would best complete the relation given below ?**

**Forest : Zoo :: Sea : ?**

- (a) Seaport (b) Aquarium  
(c) Water (d) Fish

**RRB JE - 02/06/2019 (Shift-II)**

**Ans. (b)** Just as, wild creature are kept in the zoos. Similarly, sea creatures are kept in the aquariums.

**107. Select the word pair that represents the same relation as the pair below.**

**Earth : Sun**

- (a) Universe : Space (b) Moon : Earth  
(c) Sun : Galaxy (d) Mars : Jupiter

**RRB JE - 28/06/2019 (Shift-III)**

**Ans. (b)** Just as, the earth revolves around the sun. Same as, the moon revolves around the earth.

**108. Which word would right way complete the relation given below ?**

**Needle : stitch :: Knife : ?**

- (a) Eat (b) Cut  
(c) Drive (d) Grinding

**RRB JE - 26/05/2019 (Shift-I)**

**Ans. (b)** Just as, Needle is used for stitching clothes. Same as, knife is used for cutting vegetables.

**109. Choose the most appropriate option to complete the following analogy.**

**Pen : Write :: Knife : ?**

- (a) Joint (b) Close  
(c) Cut (d) Murder

**RRB Group-D - 12/12/2018 (Shift-I)**

**Ans. (c)** Just as, pen is used to write. Same as, knife is used to cut.

**110. Select the option that is related to the third word on the same basis as the second word is related to the first word.**

**Cat : Kitten :: Sheep : ?**

- (a) Reindeer (b) Lamb  
(c) Frog baby (d) Larva

**RRB Group-D - 12/12/2018 (Shift-I)**

**Ans. (b)** Just as, baby of cat calls kitten like that baby of sheep calls lamb.

**111. Select the option that is related to the third word on the same basis as the second word is related to the first word.**

**House : Home :: Fault : ?**

- (a) Crowd (b) Sad  
(c) Accept it (d) Peace

**RPF Constable 24.01.2019 Shift : III**

**Ans. (b) :** Just as, house is related to home. Same as, fault is related to sad.

**112. Select the option that is related to the third word on the same basis as the second word is related to the first word.**

**Odometer : Motion :: Ammeter : ?**

- (a) Mass (b) Earthquake  
(c) Current (d) Air

**RRB Group-D - 11/12/2018 (Shift-II)**

**Ans. (c) :** Just as, we measure the distance travelled by the wheels of vehicles through the odometer. Same as, we measure the current from the ammeter.

**113. Select the word that is related to the third word on the same basis as the second word is related to the first word.**

**Hockey : Field :: Badminton : ?**

- (a) Arena (b) Stadium  
(c) Pitch (d) Court

**RRB Group-D - 11/12/2018 (Shift-II)**

**Ans. (d) :** Just as, hockey is played on the field. Same as, badminton is played on the court.

**114. Select the option that is related to the third word on the same basis as the second word is related to the first word.**

**Japan : Yen :: Korea : ?**

- (a) Won (b) Dollar  
(c) Pound (d) Baht

**RRB Group-D - 11/12/2018 (Shift-III)**

**Ans. (a) :** Just as, Japan's currency is Yen. Same as, currency of Korea is Won.



115. Select the option that is related to the third word on the same basis as the second word is related to the first word.

Army : Soldier :: Galaxy : ?

- (a) Alliance (b) Galaxy  
(c) Planet (d) Monsters

RRB Group-D – 23/10/2018 (Shift-III)

Ans. (c) : Just as, there are soldiers in the army. Same as, there are planets in the Galaxy.

116. Select the option that is related to the third word on the same basis as the second word is related to the first word.

Prayer : Temple :: Cook : ?

- (a) Kitchen (b) Ladle  
(c) Cooker (d) Rice

RRB Group-D – 12/10/2018 (Shift-II)

Ans. (a) : Just as, prayer held in the Temple likewise, cook is in the Kitchen.

117. Select the term that is related to the third term on the same basis as the second term is related to the first term.

Japan : Tokyo :: China : ?

- (a) Oslo (b) New Delhi  
(c) Beijing (d) Havana

RRB Group-D – 08/10/2018 (Shift-I)

Ans. (c) : Just as, capital of Japan is Tokyo. Same as, capital of China is Beijing.

118. Select the word that is related to the third word in the same basis as the second word is related to the first word ?

Chair : Furniture :: Shirt : ?

- (a) Insect (b) Garment  
(c) Drapery (d) Crockery

RRB Group-D – 08/10/2018 (Shift-III)

Ans. (b) : Just as, the chair belongs to furniture. Same as, shirt belongs to garment.

119. Select the option that is related to the third word on the same basis as the second word is related to the first word.

Understand : Argument :: Dupe : ?

- (a) Keep up (b) Con  
(c) Managed (d) Control

RRB Group-D – 05/10/2018 (Shift-III)

Ans. (b) Just as, understand is related to argument like that dupe is related to con.

120. Select the option that is related to the third word on the same basis as the second word is related to the first word.

Sound : Ear :: Scent : ?

- (a) Thought (b) Nose  
(c) Smell (d) Feel

RRB Group-D – 01/10/2018 (Shift-III)

Ans. (b) : Just as, we hear sound from ears. Same as, smell the scent through our nose.

121. Just like the second term is related to the first term, choose the fourth term corresponding to the third term.

Magnetic field : Oersted :: Power : ?

- (a) Liter (b) Meter  
(c) Watt (d) Volt

RRB Group-D – 01/10/2018 (Shift-III)

Ans. (c) : Just as, Magnetic field is related to scientist Hans Christian oersted. Same as, power is related to scientist James Watt.

122. Select the word that is related to the third word on the same basis as the second word is related to the first word.

Petrol : Car :: Electric : ?

- (a) Dark (b) Room  
(c) Thing (d) Bulb

RRB Group-D – 28/09/2018 (Shift-III)

Ans. (d) : Just as, petrol is required to drive a car. Similarly, electric is required to light a bulb.

123. Select the option that is related to the third word on the same basis as the second word is related to the first word.

Hot : Cold :: Speak : ?

- (a) Peaceful mind (b) Quiet  
(c) Walk (d) Silence

RRB Group-D – 23/09/2018 (Shift-II)

Ans. (d) : Just as, hot and cold is opposite of each other. Similarly, speak and silence is also opposite of each other.

124. Select the option that is related to the third word on the same basis as the second word is related to the first word.

Wrist : Watch :: Finger : ?

- (a) Joint (b) Ring  
(c) Thumb (d) Nail

RRB Group-D – 19/09/2018 (Shift-I)

Ans. (b) : Just as, the watch is worn on the wrist. Similarly, the ring is worn in the finger.

125. Select the option that is related to the third word on the same basis as the second word is related to the first word.

Glass : Transparent :: Wood : ?

- (a) Paint (b) Furniture  
(c) Block (d) Opaque

RRB Group-D – 18/09/2018 (Shift-I)

Ans. (d) : Just as, glass is transparent, like that wood is opaque.

126. Select the option that is related to the third term in the same way as the second term is related to the first term.

Entomology : Insects :: Etymology : ?

- (a) Plants (b) Words  
(c) Books (d) Satellites

RRB NTPC 30.12.2020 (Shift-II) Stage Ist

Ans. (b) : Just as, Insects are studied in Entomology, Similarly Words are studies in Etymology.

Hence, option (b) is the right option.

127. Which word would best complete the relation given below ?

Charminar : India :: Pyramid : ?

- (a) Canada (b) Egypt  
(c) Vatican (d) England

RRB JE - 22/05/2019 (Shift-III)

Ans. (b) : Just as, Charminar is situated in India. Same as, Pyramid is situated in Egypt.



128. Select the option that is related to the second word on the same basis as the third word is related to the fourth word.

- ..... : Spider : : Barrack : Soldier  
(a) Nest (b) Hive  
(c) Barn (d) Web

RRB Group-D – 26/11/2018 (Shift-III)

Ans : (d) Just as, 'Web' is related to spider, 'Barrack' is related to soldier.

129. Select the option that is related to the third word on the same basis as the second word is related to the first word.

- Close : Open : : Cut : .....  
(a) Attach (b) Gel  
(c) Jaw (d) Stitch

RRB Group-D – 24/09/2018 (Shift-I)

Ans : (a) Just as, close is opposite of open. Same as, cut is opposite of attach.

130. Select the option that is related to the third word on the same basis as the second word is related to the first word.

- Talk : Chat : : Pour : ?  
(a) Dispense (b) Fall  
(c) Drop (d) Drown

RRB Group-D – 05/10/2018 (Shift-I)

Ans. (a) : Just as, talk's synonyms is chat. Same as, synonyms of pour will be dispense.

131. Select the option that is related to the third word on the same basis as the second word is related to the first word.

- Meghalaya : Shillong : : Bihar : ?  
(a) Dishpur (b) Hyderabad  
(c) Lucknow (d) Patna

RRB Group-D – 05/10/2018 (Shift-I)

Ans. (d) : Just as, capital of Meghalaya is Shillong. Same as, capital of Bihar is Patna.

132. Select the option that is related to the third word on the same basis as the second word is related to the first word.

- Cry : Sob : : Laugh : ?  
(a) Exclaim (b) Bellow  
(c) Whoop (d) Chuckle

RRB Group-D – 22/10/2018 (Shift-I)

Ans : (d) Just as, sob is related to cry like that chuckle is related to laugh.

133. Select the option that is related to the third word on the same basis as the second word is related to the first word.

- Knife : Butcher : : Scissors : .....  
(a) Hair dresser (b) Wood cutter  
(c) Mechanic (d) Cobbler

RRB Group-D – 24/10/2018 (Shift-I)

Ans : (a) Just as, knife is related to butcher. Same as, scissors will be related to hair dresser.

134. Select the option that is related to the third word on the same basis as the second word is related to the first word.

- Captain : Soldier : : Employer :  
(a) Boss (b) Director  
(c) Employee (d) Officer

RRB Group-D – 24/10/2018 (Shift-I)

Ans : (c) Just as, soldier is related to Captain. Same as, employee will be related to employer.

135. Select the option that is related to the third word on the same basis as the second word is related to the first word.

- Stagnant : Flow : : Clarity : ?  
(a) Decide (b) Delusion  
(c) Mission (d) Goal

RRB Group-D – 30/10/2018 (Shift-III)

Ans. (b) : Just as, word flow is opposite of stagnant like that word delusion will be opposite of clarity.

136. Select the option that is related to the third word on the same basis as the second word is related to the first word.

- Eat : Ate : : Buy : .....  
(a) Brings (b) Buys  
(c) Bring (d) Bought

RRB Group-D – 09/10/2018 (Shift-I)

RRB Group-D – 31/10/2018 (Shift-I)

Ans : (d) Just as, second form of eat is ate. Same as, second form of buy is bought.

137. Select the option that is related to the third word on the same basis as the second word is related to the first word.

- Race : Track : : Boxing : ?  
(a) Rink (b) Ground  
(c) Ring (d) Tennis

RPF Constable 22.01.2019 Shift : I

Ans. (c) Just as, race is perform on the track likewise, boxing is perform inside the ring.

138. Select the option that is related to the third word on the same basis as the second word is related to the first word.

- Mountain : Cloud : : Desert : ?  
(a) Sand (b) Mirage  
(c) Water (d) Palm

RRB Group-D – 04/12/2018 (Shift-III)

Ans. (a) Just as, cloud is related to mountain. Same as, sand is related to desert.

139. Choose the absent word.

- Lion : Pride : : Wolf : \_\_\_\_\_ ?  
(a) Pack (b) Herd  
(c) Pod (d) Flock

RRB Group-D – 05/11/2018 (Shift-I)

Ans. (a) : Just as, pride is group of lion. Same as, pack is group of wolf.

140. Select the option that is related to the third word on the same basis as the second word is related to the first word.

- Honours : Nobility : : Humiliate : ?  
(a) Eradicate (b) Entertain  
(c) Disgrace (d) Disappear

RRB Group-D – 05/11/2018 (Shift-I)

Ans. (c) : Just as, Honours is related to Nobility. Same as, Humiliate is related to Disgrace.

141. Select the option that is related to the third word on the same basis as the second word is related to the first word.

- Wrist : Shoulder : : Ankle : \_\_\_\_\_  
(a) Hip (b) Knee  
(c) Bone (d) Joint

RRB Group-D – 05/11/2018 (Shift-II)



**Ans. (a) :** Just as, wrist is related to shoulder. Similarly, ankle is related to hip.

**142. Select the option that is related to the third word on the same basis as the second word is related to the first word.**

**Pay : Receive :: Wash : ?**

- (a) Drench (b) Soil  
(c) Neat (d) Clean

**RRB Group-D – 02/11/2018 (Shift-I)**

**Ans. (b)** Just as, receive is opposite of pay. Similarly, soil is opposite of wash.

**143. Select the option that is related to the third word on the same basis as the second word is related to the first word.**

**Prose : Poetry :: Conversation : \_\_\_\_\_**

- (a) Poem (b) Listening  
(c) Song (d) Language

**RRB Group-D – 02/11/2018 (Shift-II)**

**Ans. (c)** The way prose is related to poetry. Similarly, conversation will be related to song.

**144. Select the option that is related to the third word on the same basis as the second word is related to the first word.**

**Petty : Serious :: Yell : ?**

- (a) Whisper (b) Shout  
(c) Sing (d) Talk

**RRB Group-D – 02/11/2018 (Shift-II)**

**Ans. (a)** Just as, petty is opposite of serious. Similarly, yell will be opposite of whisper.

**145. Select the option that is related to the third word on the same basis as the second word is related to the first word.**

**Mend : Patch Up :: Bend : ?**

- (a) Mould (b) Direction  
(c) Create (d) Twist

**RRB Group-D – 01/11/2018 (Shift-II)**

**Ans. (d) :** Just as, synonyms of mend is patch up. Similarly, synonyms of bend is twist.

**146. Based on the relationship between the first two words, find out the missing word.**

**FISHES : AQUARIUM :: BIRDS : .....**

- (a) AVIARY (b) APIARY  
(c) BYRE (d) DREY

**RRB NTPC 28.04.2016 Shift : II**

**Ans. (a) :** The way fishes are kept in the aquarium just like, birds are kept in the aviary.

**147. Based on the relationship between the first two words, find out the missing word.**

**The Colosseum : Italy :: Petra : .....**

- (a) Mexico (b) Jordan  
(c) Germany (d) Brazil

**RRB NTPC 28.04.2016 Shift : II**

**Ans. (b) :** Just as, the Colosseum is situated in Italy. Similarly, Petra is situated in Jordan. Petra and the Colosseum, both are a historical place.

**148. Based on the relationship between the first two words, find out the missing word.**

**Bharatanatyam : Tamil Nadu :: Kuchipudi :**

- .....  
(a) Arunachal Pradesh (b) Odisha  
(c) Andhra Pradesh (d) Kerala

**RRB NTPC 28.04.2016 Shift : II**

**Ans. (c) :** Just as, classical dance of Tamilnadu is Bharatanatyam like that, classical dance of Andhra Pradesh is Kuchipudi.

**149. Choose the pair which is related in the same way as the words in the first pair from the given choices.**

**Error : Blunder :: ..... : Excellent**

- (a) Acceptable (b) Excel  
(c) Unsatisfactory (d) Splendid

**RRB NTPC 27.04.2016 Shift : II**

**Ans. (d) :** The way error is synonyms of blunder. Same as, splendid is synonyms of excellent.

**150. Choose the pair which is related in the same way as the words in the first pair from the given choices.**

**NEST : BIRDS :: ..... : LION**

- (a) DWELLING (b) BUSH  
(c) FOREST (d) DEN

**RRB NTPC 26.04.2016 Shift : II**

**Ans. (d) :** Just as, birds live in the nest just like, lion lives in the den.

**151. Select the pair from given alternative that are related like the words of the first pair.**

**WHISKY : DISTILLERY :: BREAD : .....**

- (a) DAIRY (b) BREWERY  
(c) BAKERY (d) BARISTA

**RRB NTPC 22.04.2016 Shift : III**

**Ans. (c)** Just as, whisky is produced in distillery. Same as, bread is manufactured in bakery.

**152. Find the correct option which has a similar relationship.**

**Produce : Waste :: Contrast : ?**

- (a) Correct (b) Match  
(c) Contradict (d) Oppose

**RRB NTPC 12.04.2016 Shift : III**

**Ans. (b) :** Just as, waste is opposite of produce. Similarly, contrast will be the opposite of match.

**153. Select the pair from given alternative that are related like the words of the first pair.**

**Gram : Grain : Pound : .....**

- (a) Cereals (b) Weight  
(c) Height (d) Commodities

**RRB NTPC 12.04.2016 Shift : II**

**Ans. (b) :** Just as, gram is a type of grain. Same as, pound is a type of weight.

**154. Based on the analogy given, find the missing word from the given options.**

**Foot : Toes :: Hand : ?**

- (a) Thumb (b) Palm  
(c) Fingers (d) Nails

**RRB NTPC 16.04.2016 Shift : I**

**Ans. (c) :** Just as, toe is related to foot, like that fingers is related to hand.

**155. Select the pair from given alternative that are related like the words of the first pair.**

**Everest : Peak :: ..... : .....**

- (a) Yamuna : River (b) Chilka : Lack  
(c) Sparrow : Bird (d) Jupiter : Planet

**RRB NTPC 16.04.2016 Shift : I**

**Ans. (d) :** Just as, Everest is the highest peak among the peaks. Same as, Jupiter is the largest planet in the planets.



156. Select the pair from given alternative that are related like the words of the first pair.

**Moth : Insect :: Mouse : .....**

- (a) Rodent (b) Cat  
(c) Mole (d) Rat

**RRB NTPC 18.04.2016 Shift : II**

**Ans. (a) :** Just as, moth is a type of insect. Same as, mouse is type of rodent.

157. Select the pair from given alternative that are related like the words of the first pair

**Night blindness : Sight :: .....** : Speech

- (a) Talk (b) Stutter  
(c) Speak (d) Lecture

**RRB NTPC 19.04.2016 Shift : II**

**Ans. (b) :** Just as, night blindness is related to sight disease. Same as, stutter is related to speech disease.

158. Select the pair from given alternative that are related like the words of the first pair.

**Circumvent : Bypass : Comprehensible : .....**

- (a) Understandable (b) Unclear  
(c) Grasping (d) Apprehended

**RPF SI 16.01.2019 Shift : I**

**Ans. (a) :** Just as, circumvent is synonyms word of Bypass. Similarly, comprehensible will be synonyms word of understandable.

159. Select the pair from given alternative that are related like the words of the first pair

**Avalanche : Ice :: Volcano : .....**

- (a) Lava (b) Sand  
(c) Heat (d) Earth

**RRB NTPC 19.04.2016 Shift : II**

**Ans. (a) :** Just as, ice is produced from avalanche. Same as, lava is produced from volcano.

160. Find the missing word of the second word pair based on the relationship established between the first two words.

**Terrestrials : Ants :: Amphibians : ...**

- (a) Fish (b) Dogs  
(c) Frogs (d) Snails

**RRB NTPC 18.01.2017 Shift : III**

**Ans. (c) :** Just as, ants is a terrestrial same as frogs is a amphibians.

161. Find the missing word of the second word pair based on the relationship established between the first two words.

**Usa : Dollar :: Turkey : .....**

- (a) Taka (b) Kyat  
(c) Lira (d) Baht

**RRB NTPC 18.01.2017 Shift : III**

**Ans. (c) :** Just as, DOLLAR is the currency of USA. Same as, Lira is the currency of Turkey.

162. Choose the related pair from the given alternatives similar to the words given in the first pair.

**Tennis : Court :: Boxing : .....**

- (a) STADIUM (b) RING  
(c) PITCH (d) GROUND

**RRB NTPC 02.04.2016 Shift : II**

**Ans. (b) :** The way Tennis is played in court. Similarly, boxing is played in the ring.

163. Choose the related pair from the given alternatives similar to the words given in the first pair.

**Cock : Hen :: Stag : .....**

- (a) Vixen (b) Hind  
(c) Goose (d) Heifer

**RRB NTPC 03.04.2016 Shift : III**

**Ans. (b) :** Just as, hen is the feminine gender of "Cock". Same as, hind is the feminine gender of "Stag".

164. Choose the related pair from the given alternatives similar to the words given in the first pair.

**West Bengal : Kolkata :: Meghalaya : ...**

- (a) Shillong (b) Dispur  
(c) Kohima (d) Trivendrum

**RRB NTPC 03.04.2016 Shift : III**

**Ans. (a) :** Just as, Kolkata is the capital of West Bengal. Same as, Shillong is the capital of Meghalaya.

165. If Artifacts : Museum then Books : .....

- (a) School (b) Book Shop  
(c) Library (d) Shelf

**RRB NTPC 04.04.2016 Shift : II**

**Ans. (c) :** Just as, artifacts are kept in the Museum. Same as, books are kept in the library.

166. Choose the related pair from the given alternatives similar to the words given in the first pair.

**Contemporary : Historic :: .....** : Ancient

- (a) Past (b) Classic  
(c) Modern (d) Future

**RRB NTPC 05.04.2016 Shift : III**

**Ans. (c) :** Just as, contemporary is the opposite word of historic. Same as, modern will be the opposite word of ancient.

167. If Voltmeter : Voltage, then Ammeter : .....

- (a) Power (b) Current  
(c) Energy (d) Pressure

**RRB NTPC 05.04.2016 Shift : II**

**Ans. (b) :** Just as, Voltmeter measured Voltage. Same as, Ammeter measured current.

168. Choose the related pair from the given alternatives similar to the words given in the first pair.

**Car : Petrol :: Locomotive : .....**

- (a) Engine (b) Fire  
(c) Coal (d) Smoke

**RRB NTPC 05.04.2016 Shift-I**

**Ans. (c) :** Just as, petrol is used into the car. Similarly, coal is used in locomotive.

169. The first pair of the word has a definite relation. Get the word of the same relation to complete the other pair.

**River : Bank :: Sea : ?**

- (a) Shore (b) Creek  
(c) Bay (d) Sand

**RRB NTPC 17.01.2017 Shift-II**

**Ans. (a) :** Just as, coast of river is called 'bank'. Same as, coast of sea is called 'shore'



170. Select the option that is related to the third word on the same basis as the second word is related to the first word.

Fish : Shoal :: Goods : \_\_\_\_\_ ?

- (a) Items (b) Stock  
(c) Gang (d) Mob

RRB Group-D – 11/12/2018 (Shift-I)

Ans. (b) : The way fish is related to shoal. Same as, goods is related to stock.

171. Select the option that is related to the third word on the same basis as the second word is related to the first word.

Vacant : Empty :: Sedate : ?

- (a) Calm (b) Cat  
(c) Car (d) Defect

RRB Group-D – 10/12/2018 (Shift-I)

Ans. (a) : Just as, vacant is synonyms word of empty. Same as, sedate is the synonyms of calm.

172. Select the option that is related to the third word on the same basis as the second word is related to the first word.

Listen : Understand :: Rest : ?

- (a) Remake (b) Enjoy  
(c) Recreate (d) Rejuvenate

RRB Group-D – 12/11/2018 (Shift-II)

Ans. (d) : The way listen is related to understand. Same as, rest will be related to Rejuvenate.

173. Select the option that is related to the third word on the same basis as the second word is related to the first word.

Eradicate : Destroy : Pleasure : \_\_\_\_\_ ?

- (a) Damp (b) Sad  
(c) Feel (d) Delight

RRB Group-D – 31/10/2018 (Shift-III)

Ans. (d) : Just as, Destroy is the synonyms of Eradicate. Same as Delight is the synonyms of Pleasure.

174. Select the option that is related to the third word on the same basis as the second word is related to the first word.

Bow : Arrow : \_\_\_\_\_ : Bullet

- (a) Fire (b) Gun  
(c) Train (d) shoot

RRB Group-D – 31/10/2018 (Shift-III)

Ans. (b) : Just as, Arrow is used in Bow. Same as, Bullet is used in Gun.

175. Select the option that is related to the third word on the same basis as the second word is related to the first word.

Left : Right :: Vertical : .....

- (a) Straight (b) Horizontal  
(c) Flat (d) Down

RRB Group-D – 26/10/2018 (Shift-II)

Ans. (b) : Just as, Left is opposite of Right. Same as, Vertical is opposite of Horizontal.

176. Select the option that is related to the third word on the same basis as the second word is related to the first word.

Wall : Block :: Window : ?

- (a) Sill (b) Open  
(c) Air (d) Gaze

RRB Group-D – 26/10/2018 (Shift-II)

Ans. (b) : The way block is related to wall. Same as, open is related to window.

177. Select the word that is related to the fourth word on the same basis as the first word is related to the second word.

Hand : Glove :: Head : ?

- (a) Gel (b) Oil  
(c) Shampoo (d) Shower cap

RRB Group-D – 25/10/2018 (Shift-II)

Ans : (d) Just as, Glove wears on Hand. Same as, Shower cap wears on Head.

178. Select the option that is related to the third word on the same basis as the second word is related to the first word.

Bee : Sting :: Snake : ?

- (a) Eat (b) Crawl  
(c) Bite (d) Hiss

RRB Group-D – 25/10/2018 (Shift-II)

Ans : (c) Just as, Bee has its sting which is injects into body of an attacker. Similarly, Snakes is related to bite.

179. Select the word that is related to the third word on the same basis as the second word is related to the first word.

Heart: Cardiologist :: Bone : ?

- (a) Orthopaedist (b) Orthodontist  
(c) Orthocare (d) Dermatologist

RRB Group-D – 23/10/2018 (Shift-I)

Ans. (a) : Just as, Cardiologist treats Heart related diseases. Same as, Orthopaedist treats Bone related diseases.

180. Select the word that is related to the third word on the same basis as the second word is related to the first word.

Volcano : Lava :: Fire : ?

- (a) Burns (b) Smoke  
(c) Light (d) Flashes

RRB Group-D – 23/10/2018 (Shift-II)

Ans. (b) : Just as, lava emits from volcano. Similarly, smoke emits from Fire.

181. Select the option that is related to the third word on the same basis as the second word is related to the first word.

Turbid : Clear :: Apparent :

- (a) Sensible (b) Credible  
(c) Obscure (d) Outward

RRB Group-D – 08/10/2018 (Shift-I)

Ans. (c) : Just as, Turbid is the opposite of clear. Same as, apparent is the opposite of obscure.

182. Select the option that is related to the third word on the same basis as the second word is related to the first word.

Wait : Linger :: Bite :

- (a) Eat (b) Gnaw  
(c) Hiss (d) Murmur

RRB Group-D – 04/10/2018 (Shift-I)

Ans. (b) The way linger is related to wait that way gnaw is related to bite.

183. Select the option that is related to the third word on the same basis as the second word is related to the first word.

Earth : Ball :: Pancake : .....

- (a) Flat (b) Soccer  
(c) Disc (d) Flag

RRB Group-D – 01/10/2018 (Shift-I)



**Ans. (c) :** Just as, the earth is shaped like a ball. Same as, pancake is shaped like a disc.

**184. Select the option that is related to the third word on the same basis as the second word is related to the first word.**

**Want : Yearn :: Punish :**

- (a) Shout (b) Jail  
(c) Reprimand (d) Snub

**RRB Group-D – 01/10/2018 (Shift-I)**

**Ans. (c) :** Just as, want is the synonyms of yearn just like punish is also synonyms of reprimand.

## Type - 2

**185. Rafting is related to water as Skiing is related to**

- (a) Ice (b) Surface  
(c) Sneeze (d) Sky

**RRB NTPC 05.04.2021 (Shift-II) Stage Ist**

**Ans. (a) :** Just as rafting is related to water, in the same way Skiing is related to Ice/Snow.

**186. Heart is related to 'Cardiology' in the same way as kidney is related to \_\_\_\_\_**

- (a) Nuclear Medicine (b) Nephrology  
(c) Neurology (d) Rheumatology

**RRB NTPC 10.01.2021 (Shift-I) Stage Ist**

**Ans. (b) :** Just as, the heart is studied under cardiology, same as the kidney is studied under Nephrology.

**187. 'Gloves' is related to 'Hand' in the same way as 'Cap' is related to '.....'.**

- (a) Neck (b) Back  
(c) Head (d) Foot

**RRB NTPC 12.01.2021 (Shift-I) Stage Ist**

**Ans. (c) :** Just as, Gloves wears in Hands same as Cap wears on Head.

**188. 'Hand' is related to 'Finger' in the same way as 'Pen' is related .....**

- (a) Nib (b) Pencil  
(c) Ink (d) Holder

**RRB NTPC 04.02.2021 (Shift-I) Stage Ist**

**Ans. (a) :** Just as, the work of the fingers in the hand is to hold the objects, in the same way the work of the nib in the pen is to write.

**189. 'Hinhinana' (neigh) is related to 'Horse' in the same way as 'Mimiana' (bleat) is related to.**

- (a) Dog (b) Bear  
(c) Ass (d) Goat

**RRB NTPC 29.12.2020 (Shift-II) Stage Ist**

**Ans. (d) :** Just as, the sound of the horse is neigh in the same way the sound of the goat is bleat.

**190. As India is related to 'New Delhi', China is related to \_\_\_\_\_.**

- (a) Pyongyang (b) Seoul  
(c) Beijing (d) Tokyo

**RRB NTPC 29.12.2020 (Shift-II) Stage Ist**

**Ans. (c) :** Just as, the capital of India is 'New Delhi', in the same way the capital of China is 'Beijing'.

**191. 'Garden' is related to 'Gardener' in the same way as 'Museum' is related to '\_\_\_\_\_'.  
(a) Museology (b) Curator  
(c) Artist (d) Guide**

**RRB NTPC 30.12.2020 (Shift-I) Stage Ist**

**Ans. (b) :** Just as, Garden is related to Gardener in same way Museum is related to Curator.

**192. 'Manipur' is related to 'Imphal' in the same way as 'Nagaland' is related to '\_\_\_\_\_'.  
(a) Gangtok (b) Aizawl  
(c) Shilong (d) Kohima**

**RRB NTPC 09.01.2021 (Shift-I) Stage Ist**

**Ans. (d) :** Just as, 'Imphal' is the capital of Manipur. Same as, 'Kohima' is the capital of Nagaland.

**193. 'Church' is related to 'Christians' in the same way 'Synagogue' is related to '\_\_\_\_\_'.  
(a) Muslims (b) Jews  
(c) Parsis (d) Jains**

**RRB NTPC 09.01.2021 (Shift-I) Stage Ist**

**Ans. (b) :** Just as, Church is the place of worship of Christians. Similarly, "Synagogue" is the worship place of Jews.

**194. 'Light' is related to 'Darkness' in the same way as 'Transparent' is related to '\_\_\_\_\_'.  
(a) Glass (b) Translucent  
(c) Paper (d) Opaque**

**RRB NTPC 17.01.2021 (Shift-II) Stage Ist**

**Ans. (d) :** Just as, antonyms of 'light' is 'dark' similarly antonyms of 'transparent' is 'opaque'.

**195. 'Cricket' is related to 'Bat', in the same way as 'Tennis' is related to '\_\_\_\_\_'.  
(a) Glove (b) Stick  
(c) Wicket (d) Racquet**

**RRB NTPC 04.02.2021 (Shift-II) Stage Ist**

**Ans. (d) :** Just as, Bat is used to play cricket. Similarly, Racquet is used to play tennis.

**196. Select a word from the following four options that is related to the word 'South Africa' in the same way as the word 'Persian' is related to the word 'Iran'.  
(a) Country (b) Portuguese  
(c) Africa (d) English**

**RRB NTPC 10.02.2021 (Shift-II) Stage Ist**

**Ans. (d) :** Just as, Persian language is spoken in Iran. Similarly, English is spoken in South Africa.

**197. 'Income' is related to which of the following options in the same way as 'Expenditure' is related to 'EMI' ?  
(a) Salary (b) Revenue  
(c) Profit (d) Tax**

**RRB NTPC 03.03.2021 (Shift-II) Stage Ist**

**Ans. (a) :** Just as, Income is related with salary. Similarly, Expenditure is related with EMI.



198. Omelete is related to Egg in the same way as metal is related to:

- (a) Ore (b) Iron  
(c) Gold (d) Aluminium

RRB NTPC 03.03.2021 (Shift-II) Stage Ist

Ans. (a) : Just as, - Omelete is obtained from eggs.  
Same as - Metal is obtained from Ore.

199. A saw is related to wood in the same way as a knife \_\_\_\_\_?

- (a) Vegetables (b) Steel  
(c) Cloth (d) Cutter

RRB NTPC 05.04.2021 (Shift-II) Stage Ist

Ans. (a) : Just as, wood is cut with a saw, in the same way vegetables are cut with a knife.

200. Which of the following is same as foot, inch and yard?

- (a) Gram (b) Mile  
(c) Quart (d) Pound

RRB NTPC 10.01.2021 (Shift-II) Stage Ist

Ans. (b) : Mile is same as foot, inch and yard because these are units of length.

201. 'Supply' is related to 'Demand' in the same way as 'Production' is related to '\_\_\_\_\_'.  
(a) Factory (b) Inventory  
(c) Income (d) Consumption

RRB NTPC 18.01.2021 (Shift-II) Stage Ist

Ans. (d) : Just as, supply is related to demand. Same as, Production is related to consumption.

202. 'Cold' is related to 'Refrigerator' in the same way as 'Hot' is related to '\_\_\_\_\_'.  
(a) Air conditioner (b) Fire  
(c) Grinder (d) Oven

RRB NTPC 14.03.2021 (Shift-II) Stage Ist

Ans. (d) : Just as, a refrigerator is used to cool a thing, in the same way oven is used to heat something.

203. 'Minute' is related to 'Hour' in the same way as 'Inch' is related to '\_\_\_\_\_'.  
(a) Measure (b) Foot  
(c) Centigrade (d) Metre

RRB NTPC 20.01.12021 (Shift-II) Stage Ist

Ans. (b) : Just as, 'Minute' is related to 'Hour'. Similarly 'Inch' is related to 'Foot'.

204. Select the option that is related to the 'Paisa' in the same way as the 'centimetre' is related to the metre.  
(a) Capital (b) Wealth  
(c) Rupee (d) Coin

RRB NTPC 22.01.2021 (Shift-I) Stage Ist

Ans. (c) : Just as, 100 cm makes 1 meter, in the same way 100 paise makes 1 rupee.

Hence, option (c) will be correct answer.

205. 'Painting' is related to 'Brush' in the same way as 'Letter' is related to '\_\_\_\_\_'.  
(a) Post-Office (b) Writer  
(c) Ink (d) Pen

RRB NTPC 30.01.2021 (Shift-II) Stage Ist

Ans. (d) : Just as, by 'brush' we do 'painting' work. Similarly, by 'pen' we do letter 'writing' work.

206. 'Day' is related to 'Night' in the same way as 'Cold' is related to '\_\_\_\_\_'.  
(a) Fire (b) Winter  
(c) Wet (d) Hot

RRB NTPC 09.02.2021 (Shift-II) Stage Ist

Ans. (d) : Just as, the antonym of 'day' is 'night'. Similarly, antonym of 'Cold' is 'hot'.

207. 'Story' is related to 'Reader' in the same way as '\_\_\_\_\_ ' is related to 'Listener'.  
(a) Song (b) Singer  
(c) Dance (d) Lyrics

RRB NTPC 17.02.2021 (Shift-II) Stage Ist

Ans. (a) : Just as, Story is related reader.

Same as, Song is related to Listener.

208. 'Waiter' is related to 'Restaurant' in the same way as 'Worker' is related to '\_\_\_\_\_'.  
(a) School (b) Factory  
(c) House (d) Shop

RRB NTPC 17.02.2021 (Shift-II) Stage Ist

Ans. (b) : Just as, waiter related to restaurant. Similarly, worker is related to factory.

209. Animal is related to Zoology in the same way as Disease is related to:  
(a) Cardiology (b) Botany  
(c) Pathology (d) Astrology

RRB NTPC 27.02.2021 (Shift-II) Stage Ist

Ans. (c) : Just as, Animal is related to Zoology. Similarly, Disease is related to Pathology.

210. What is related to 'Furniture' in the same way as 'Building' is related to 'Mason'?  
(a) Carpenter (b) Wood  
(c) Designer (d) Contractor

RRB NTPC 27.02.2021 (Shift-II) Stage Ist

Ans. (a) . Just as, Mason builds a Building. Similarly, Carpenter makes a Furniture.

211. Car is related to tire in the same way as chair is related to-  
(a) Back (b) Sit  
(c) Rest (d) Legs

RRB Group-D - 28/09/2018 (Shift-II)

Ans. (d) Just as, car is related to tire in the same way chair is related to legs.

212. 'Miss' is related to 'Hit' in same way 'Late' is related to?  
(a) 'Time' (b) 'Early'  
(c) 'Appointment' (d) 'Day'

RRB Group-D - 16/11/2018 (Shift-I)

Ans. (b) : Just as, miss is opposite of hit .Same as, late is opposite of early.

213. Just as, Linen is related to cloths in the same way gold is related to.  
(a) Metal (b) Goldsmith  
(c) Hard (d) Yellow

RRB Group-D - 22/09/2018 (Shift-III)

**Ans. (a) :** Just as, linen is related to cloths, in the same way gold is related to metal.

**214. Just as, pond is related to water in the same way as mountain has following to.**

- (a) Bird (b) Stone  
(c) Climb (d) Animal

**RRB Group-D – 27/09/2018 (Shift-I)**

**Ans. (b)** The pond is related to water, in the same way as mountain is related to stone.

**215. Just as, 'fast' is related to airplane in the same way dim is related to.**

- (a) Walk (b) Workout  
(c) Run (d) Bullock Cart

**RRB Group-D – 03/12/2018 (Shift-II)**

**Ans. (d) :** Just as, 'fast' is related to airplane in the same way dim is related to Bullock Cart.

**216. Just as, break is related to seal in the same way as talk has to.**

- (a) Calm (b) Grumble  
(c) Silent (d) Peace

**RRB Group-D – 03/12/2018 (Shift-III)**

**Ans. (c) :** Just as, Break is opposite of seal in the same way as Talk is opposite of silent.

**217. Just as, New is related to Old in the same way Day is related to.**

- (a) Bright (b) Sun  
(c) Time (d) Night

**RRB Group-D – 27/11/2018 (Shift-I)**

**Ans. (d) :** Just as, New is opposite of Old. Same as, Day is opposite of Night.

**218. Just as, Check is related to Validate in the same way Make is related to.**

- (a) 'Create' (b) 'Late'  
(c) 'Protect' (d) 'Grow'

**RPF Constable 22.01.2019 Shift : II**

**Ans. (a)** Just as, 'Check' is related to 'Validate', in the same way 'Make' is related to 'Create'.

**219. Just as, Knife is related to Cut in the same way Spanner is related to.**

- (a) Mechanic (b) Grip  
(c) Grind (d) Drill

**RRB Group-D – 16/11/2018 (Shift-I)**

**Ans. (b) :** Just as, 'Knife' is related to 'Cut' in the same way 'Spanner' is related to 'Grip'.

**220. Blue is related to Sky in the same way as Brown is related to:**

- (a) Mud (b) Wet  
(c) Vessel (d) Board

**RRB Group-D – 05/11/2018 (Shift-III)**

**Ans. (a) :** Just as, 'Blue' is related to 'Sky' in the same way as 'Brown' is related to 'Mud'.

**221. Lion is related to Roar, in the same way as Horse is related to \_\_\_\_\_.**

- (a) Hiss (b) Neigh  
(c) Bray (d) Hoot

**RRB Group-D – 05/11/2018 (Shift-III)**

**Ans. (b) :** Just as, 'Lion' is related to 'Roar', in the same way as 'Horse' is related to 'Neigh'.

**222. If there is a page from book then, what is there through the window ?**

- (a) Forest (b) Wood  
(c) Window Glass (d) Room

**RPF SI 16.01.2019 Shift : II**

**Ans. (c) :** Just as, a book has page. Similarly, window has a window glass.

**223. Fish-herd is related to fish that colony belongs to.**

- (a) Ants (b) Cow  
(c) Home (d) Life

**RRB NTPC 28.03.2016 Shift : III**

**Ans. (a) :** Just as, herd is a group of Fish. Similarly, Colony is a group of to Ants.

**224. Solar is related to sun in the same way lunar is related to.**

- (a) Lunatic (b) Planet  
(c) Moon (d) Star

**RRB NTPC 30.03.2016 Shift : II**

**Ans. (c) :** The way Solar is related to Sun in the same way Lunar is related to Moon.

**225. If Quarantine : Isolation, then Freedom: \_\_\_\_\_**

- (a) Separation (b) Detention  
(c) Liberation (d) Constitution

**RRB NTPC 30.03.2016 Shift : I**

**Ans. (c) :** If quarantine means isolation, then freedom means liberation.

**226. 'Car' is related to 'Garage' in the same way as 'Hen' is related to \_\_\_\_\_.**

- (a) Kennel (b) Shed  
(c) Coop (d) Stable

**RRB ALP & Tec. (14-08-18 Shift-I)**

**Ans. (c) :** Just as, 'Car' is related to 'Garage' in the same way as 'Hen' is related to 'Coop'.

**227. Shoes is related to Slipper in the same way Coat is related to.**

- (a) Shirt (b) Pen  
(c) Socks (d) Tie

**RRB Group-D – 11/12/2018 (Shift-I)**

**Ans. (a) :** The way 'Shoes' is related to 'Slipper' in the same way 'Coat' is related to 'Shirt'.

## Type - 3

**228. In the given letter-cluster pairs, the first letter-cluster is related to the second letter-cluster following a certain logic. Study the given pairs carefully, and from the given options, select the pair that follows the same logic.**

**TPN : XTR**

**LSK : PWO**

- (a) MZC : DGQ (b) QGD : CMZ  
(c) ZMC : DQG (d) DQG : ZMC

**RRB Group-D 28-09-2022 (Shift-II)**

**Ans. (c) :** Just as, And,

T  $\xrightarrow{+4}$  X L  $\xrightarrow{+4}$  P

P  $\xrightarrow{+4}$  T S  $\xrightarrow{+4}$  W

N  $\xrightarrow{+4}$  R K  $\xrightarrow{+4}$  O

Similarly, from option (c)-

Z  $\xrightarrow{+4}$  D

M  $\xrightarrow{+4}$  Q

C  $\xrightarrow{+4}$  G



229. In the given letter-cluster pairs, the first letter-cluster is related to the second letter-cluster following a certain logic. Study the given pairs carefully, and from the given options, select the pair that follows the same logic.

YVQ : TQL

WKG : RFB

(a) SIY : NDT (b) DUR : APM

(c) FHL : Clu (d) QHK : JSP

RRB Group-D 28-09-2022 (Shift-I)

Ans. (a) : Just as, And,

Y $\xrightarrow{-5}$ T	W $\xrightarrow{-5}$ R
V $\xrightarrow{-5}$ Q	K $\xrightarrow{-5}$ F
Q $\xrightarrow{-5}$ L	G $\xrightarrow{-5}$ B

Same as, from option (a)-

S $\xrightarrow{-5}$ N	I
I $\xrightarrow{-5}$ D	D
Y $\xrightarrow{-5}$ T	T

230. Select the option that is related to the fifth letter-cluster in the same way as the second letter-cluster is related to the first letter-cluster and the fourth letter-cluster is related to the third letter-cluster.

ZCD : XAB :: MDV : KBT :: RNT : ?

(a) PLR (b) POT

(c) QRU (d) PMR

RRB Group-D 14-09-2022 (Shift-I)

Ans. (a) : Just as,

Z C D	M D V
-2 ↓ -2 ↓ -2 ↓	-2 ↓ -2 ↓ -2 ↓
X A B	K B T

Same as,

R N T	
-2 ↓ -2 ↓ -2 ↓	
P L R	

Hence, RNT is coded as PLR.

231. In the given letter-cluster pairs, the first letter-cluster is related to the second letter-cluster following a certain logic. Study the given pairs carefully, and from the given options, select the pair that follows the same logic.

MON : PLQ

KIT : NFW

(a) LPG : OMK (b) TAP : WYS

(c) PEN : SBQ (d) PET : SIW

RRB Group-D 30-08-2022 (Shift-I)

Ans. (c) : Just as,

M $\xrightarrow{+3}$ P	K $\xrightarrow{+3}$ N
O $\xrightarrow{-3}$ L	I $\xrightarrow{-3}$ F
N $\xrightarrow{+3}$ Q	T $\xrightarrow{+3}$ W

Same as,

P $\xrightarrow{+3}$ S	
E $\xrightarrow{-3}$ B	
N $\xrightarrow{+3}$ Q	

Hence, PEN is coded as SBQ.

232. In the given letter-cluster pairs, the first letter-cluster is related to the second letter-cluster following a certain logic. Study the given pairs carefully, and from the given options, select the pair that follows the same logic.

ABC : EFG

PQR : TUV

(a) XYZ : BCD (b) PKL : RSM

(c) MNO : PQR (d) GHI : DEF

RRB Group-D 14-09-2022 (Shift-I)

Ans. (a) : Given,

A	B	C	E	F	G
		+4			
		+4			
		+4			
P	Q	R	T	U	V

Similarly, from option (a)-

X	Y	Z	B	C	D
		+4			
		+4			
		+4			

Hence, XYZ is coded as BCD.

233. Select the option that is related to the fifth letter-cluster in the same way as the second letter-cluster is related to the first letter-cluster and the fourth letter-cluster is to the third letter-cluster.

HUDK : KWGM :: RBNF : UDQH :: LPQV : ?

(a) OSTY (b) NRSX

(c) NSSY (d) ORTX

RRB NTPC (Stage-II) -14/06/2022 (Shift-II)

Ans. (d) : Just as,

H	U	D	K	W	G	M
		+3				
		+2				
		+3				
		+2				

And,

R	B	N	F	U	D	Q	H
		+3					
		+2					
		+3					
		+2					

Same as,

L	P	Q	V	O	R	T	X
		+3					
		+2					
		+3					
		+2					

234. Select the option that is related to the fifth letter-cluster in the same way as the second letter-cluster is related to the first letter-cluster and the fourth letter-cluster is related to the third letter-cluster.

KSQ : OWU :: FIJ : JMN :: TPV : ?

- (a) ZSY (b) XRX  
(c) XYZ (d) XTZ

RRB NTPC (Stage-II) –16/06/2022 (Shift-II)

Ans. (d) : Just as,

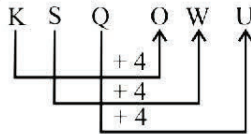

and,

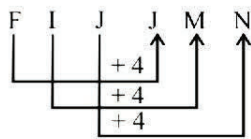

Same as,

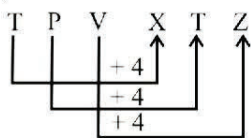

Hence, ? = XTZ

235. Select the option that is related to the sixth letter-cluster in the same way as the first letter-cluster is related to the second letter-cluster and the third letter-cluster is related to the fourth letter-cluster.

OSU : LQT :: IKL : FIK :: ? : JTB

- (a) MVC (b) MWC  
(c) NVD (d) NUD

RRB NTPC (Stage-II) –16/06/2022 (Shift-II)

Ans. (a) : Just as,

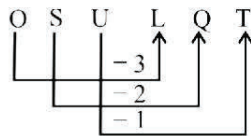

and,

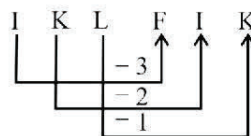

Same as,

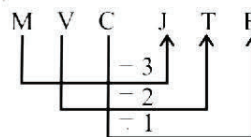

Hence, ? = MVC

236. Select the option that is related to the sixth letter-cluster in the same way as the first letter-cluster is related to the second letter-cluster and the third letter-cluster is related to the fourth letter-cluster.

GCN : LHS :: OQU : TVZ :: ? : KRY

- (a) GNT (b) ENS  
(c) DMQ (d) FMT

RRB NTPC (Stage-II) –16/06/2022 (Shift-III)

Ans. (d) : Just as,

G  $\xrightarrow{+5}$  L

C  $\xrightarrow{+5}$  H

N  $\xrightarrow{+5}$  S

and,

O  $\xrightarrow{+5}$  T

Q  $\xrightarrow{+5}$  V

U  $\xrightarrow{+5}$  Z

Same as,

F  $\xrightarrow{+5}$  K

M  $\xrightarrow{+5}$  R

T  $\xrightarrow{+5}$  Y

237. Select the option that is related to the fifth letter-cluster in the same way as the fourth letter-cluster related to the third letter-cluster and second letter-cluster is related to the first letter-cluster.

FTPY : JVTA :: NVZG : RXDI :: MPRE : ?

- (a) QSVH (b) QRVG  
(c) PSUH (d) PRUG

RRB NTPC (Stage-II) –17/06/2022 (Shift-I)

Ans. (b) : Just as,

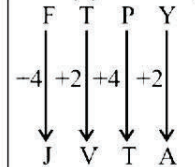

And,

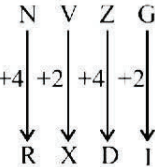

Same as,

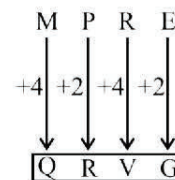

238. Select the option that is related to the fifth letter-cluster in the same way as the fourth letter-cluster related to the third letter-cluster and second letter-cluster is related to the first letter-cluster.

IGRS : NJWV :: BMYF : GPDI :: XQSB : ?

- (a) CUXF (b) BTWE  
(c) BUWF (d) CTXE

RRB NTPC (Stage-II) –17/06/2022 (Shift-I)



Ans. (d) : Just as,

I  $\xrightarrow{+5}$  N  
 G  $\xrightarrow{+3}$  J  
 R  $\xrightarrow{+5}$  W  
 S  $\xrightarrow{+3}$  V

And,

B  $\xrightarrow{+5}$  G  
 M  $\xrightarrow{+3}$  P  
 Y  $\xrightarrow{+5}$  D  
 F  $\xrightarrow{+3}$  I

Same as,

X  $\xrightarrow{+5}$  C  
 Q  $\xrightarrow{+3}$  T  
 S  $\xrightarrow{+5}$  X  
 B  $\xrightarrow{+3}$  E

239. Select the option that is related to fifth letter-cluster in the same way as the second letter-cluster is related to the first letter-cluster and the fourth letter-cluster is related to the third letter-cluster.

PJEB : SQHI :: MCQX : PJTE : ?

- (a) OWFY (b) OYFA  
 (c) QWHY (d) QYHA

RRB NTPC (Stage-II) -17/06/2022 (Shift-II)

Ans. (b) : Just as,

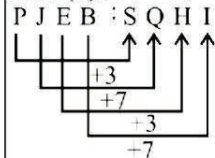

and,

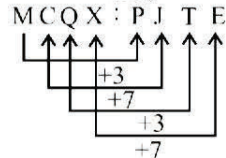

Same as,

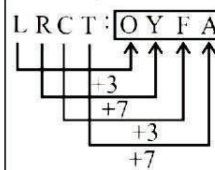

240. Select the option that is related to the fifth letter-cluster in the same way as the second letter-cluster is related to the first letter-cluster and the fourth letter-cluster is related to the third letter-cluster.

WJOF : ZORK :: CPNY : FUQD : ?

- (a) CWQI (b) AWOI  
 (c) AUOG (d) CUQG

RRB NTPC (Stage-II) -17/06/2022 (Shift-II)

Ans. (b) : Just as,

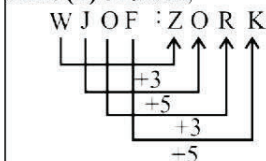

and,

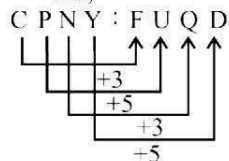

Same as,

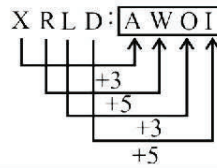

241. Select the option that is related to the fifth letter-cluster in the same way as the second letter-cluster is related to the first letter-cluster and the fourth letter-cluster is related to the third letter-cluster.

EYXJ : IGBR :: CRFQ : GZJY :: ZIQM : ?

- (a) DNUR (b) ENVR  
 (c) DQUU (d) EQVU

RRB NTPC (Stage-II) -17/06/2022 (Shift-III)

Ans. (c) : Just as,

E  $\xrightarrow{+4}$  I  
 Y  $\xrightarrow{+8}$  G  
 X  $\xrightarrow{+4}$  B  
 J  $\xrightarrow{+8}$  R

And,

C  $\xrightarrow{+4}$  G  
 R  $\xrightarrow{+8}$  Z  
 F  $\xrightarrow{+4}$  J  
 Q  $\xrightarrow{+8}$  Y

Same as,

Z  $\xrightarrow{+4}$  D  
 I  $\xrightarrow{+8}$  Q  
 Q  $\xrightarrow{+4}$  U  
 M  $\xrightarrow{+8}$  U

242. In the given letter-cluster pairs, the first letter-cluster is related to the second letter-cluster following a certain logic. Study the given pairs carefully, and from the given options, select the pair that follows the same logic.

POT : UPQ

EST : UTF

- (a) CAT : UBD (b) TWO : UPU  
 (c) MEN : NFO (d) PTU : VUV

RRB Group-D-29/08/2022 (Shift-III)

Ans.(a) : Just as,

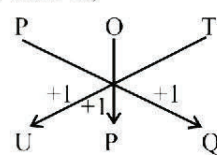

and,

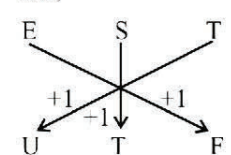

Similarly from option (a),

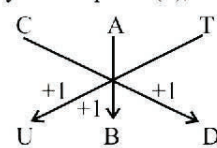

Hence, CAT is coded as UBD.

243. In the given letter-cluster pairs, the first letter-cluster is related to the second letter-cluster following a certain logic. Study the given pairs carefully and from the given options, select the pair that follows the same logic.

**QJD : TMG**

**GMS : JPV**

- (a) MYO : PQJ (b) NIH : SXB  
(c) RPH : USK (d) AWL : ZDT

**RRB Group-D- 26/08/2022 (Shift-I)**

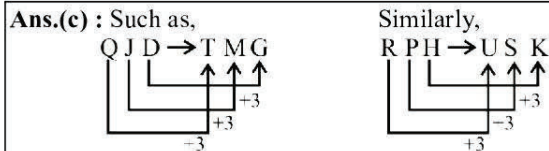

and,

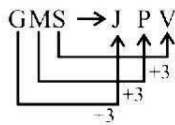

Hence, RPH is coded as USK.

244. In the given letter-cluster pairs, the first letter-cluster is related to the second letter-cluster following a certain logic. Study the given pairs carefully and from the given option, select the pair that follows the same logic.

**ADG : EHK**

**TJF : XNJ**

- (a) KOH : OSL (b) JQR : NTV  
(c) FJW : HLZ (d) IPD : RKW

**RRB Group-D- 30/09/2022 (Shift-I)**

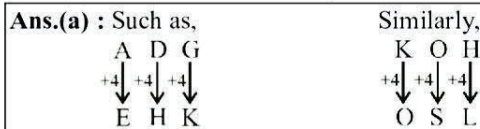

and,

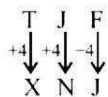

Hence, KOH is coded as OSL.

245. In the given letter-cluster pairs, the first letter-cluster is related to the second letter-cluster following a certain logic. Study the given pairs carefully, and from the given options, select the pair that follows the same logic.

**BLG : DHM**

**GMQ : IIW**

- (a) QDR : TZX (b) ULF : WGL  
(c) CNH : EIJ (d) YPJ : ATP

**RRB Group-D- 29/08/2022 (Shift-I)**

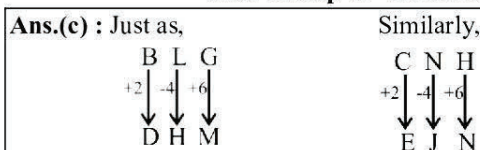

and,



Hence, option (c) is correct.

246. In the given letter-cluster pairs, the first letter-cluster is related to the second letter-cluster following a certain logic. Study the given pairs carefully, and from the given options, select the pair that follows the same logic.

**IGE : QOM :: YWU : GEC**

- (a) NLJ : VTR (b) ONL : XWU  
(c) PQR : MLK (d) PNM : UTS

**RRB Group-D- 08/09/2022 (Shift-II)**

**Ans.(a) :** Just as,



and,

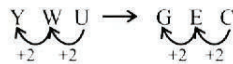

Similarly,



Hence option (a) is correct answer.

247. In the given letter-cluster pairs, the first letter-cluster is related to the second letter-cluster following a certain logic. Study the given pairs carefully and from the given options, select the pair that follows the same logic.

**HP : MS**

**DL : IO**

- (a) GE : LI (b) AL : FO  
(c) GR : KT (d) HT : KY

**RRB Group-D- 15/09/2022 (Shift-III)**

**Ans. (b) :** Just as,

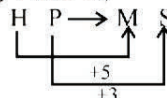

Similarly,

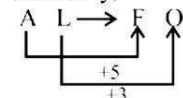

and,

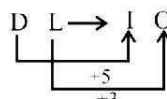

Hence, option (b) is correct answer.

248. In the given letter-cluster triads, the letter-cluster in a particular triad are related following a certain logic. Study the given triads carefully and from the given options, select the triad that follows the same logic.

**(ACE : BDF : CEG)**

**(SUW : TVX : UWY)**

- (a) (ACF : BDE : CFH)  
(b) (KMO : LNP : MOQ)  
(c) (QRS : TUV : WXY)  
(d) (SUW : TVX : YAC)

**RRB Group-D- 08/09/2022 (Shift-I)**



**Ans.(b) :** Just as,                      and                      Similarly

A	C	E	S	U	W	K	M	O
-1↓	-1↓	+1↓	-1↓	+1↓	+1↓	+1↓	+1↓	+1↓
B	D	F	T	V	X	L	N	P
-1↓	-1↓	+1↓	-1↓	+1↓	+1↓	+1↓	+1↓	+1↓
C	E	G	U	W	Y	M	O	Q

249. Select the option that is related to the fifth letter-cluster in the same way as the second letter-cluster is related to the first letter-cluster and the fourth letter-cluster is related to the third letter-cluster.

PATN : APNT :: MODE : OMED :: JUST : ?

- (a) UJTS                      (b) TUJS  
(c) JTUS                      (d) SUJT

RRB Group-D- 06/10/2022 (Shift-II)

**Ans.(a) :** Such as,                      Similarly,

P	A	T	N	J	U	S	T
↘	↘	↘	↘	↘	↘	↘	↘
A	P	N	T	U	J	T	S

And,

M	O	D	E
↘	↘	↘	↘
O	M	E	D

Hence option (a) is correct answer.

250. In the given letter-cluster pairs, the first letter-cluster is related to the second letter-cluster following a certain logic. Study the given pairs carefully and from the given options, select the pair that follows the same logic.

HTY : ZVK

KUY : ZWN

- (a) KYT : WAL                      (b) ABG : HCD  
(c) APK : BRN                      (d) AED : EGD

RRB Group-D- 09/09/2022 (Shift-III)

**Ans.(d) :** Such as,                      Similarly,

H	T	Y	A	E	D
+1	-2	+3	+1	-2	+3
Z	V	K	E	G	D

And,

K	U	Y
+1	-2	+3
Z	W	N

Hence option (d) is correct answer.

251. Select the option that is related to the fifth letter-cluster in the same way as the second letter-cluster is related to the first letter-cluster and the fourth letter-cluster is related to the third letter-cluster.

DXB : GSI :: KVR : NQY :: JNP : ?

- (a) MIW                      (b) NIW  
(c) MHW                      (d) MIV

RRB Group-D- 18/09/2022 (Shift-III)

**Ans.(a) :** Such as,                      Similarly,

D	X	B	J	N	P
+3	-5	+7	-3	-5	+7
G	S	I	M	I	W

And,

K	V	R
-3	-5	-7
N	Q	Y

Hence ? = MIW

252. In the given letter-cluster pairs, the first letter-cluster is related to the second letter-cluster following a certain logic. Study the given pairs carefully, and from the given options, select the pair that follows the same logic.

ALM : EPQ

NSO : RWS

- (a) FVD:GOS                      (b) SLT:RVM  
(c) FPG:JTK                      (d) OSD:PCV

RRB Group-D- 15/09/2022 (Shift-II)

**Ans. (c) :** Such as,                      And,

A	L	M	N	S	O
-4	-4	+4	-4	+4	+4
E	P	Q	R	W	S

Similarly, from option (c),

F	P	G
-4	+4	+4
J	T	K

253. In the given letter-cluster pairs, the first letter-cluster is related to the second letter-cluster following a certain logic. Study the given pairs carefully, and from the given options, select the pair that follows the same logic.

MGB : NTY

THK : GSP

- (a) CHX : XIC                      (b) LCP : OXJ  
(c) QDF : JWU                      (d) MEF : NVH

RRB Group-D- 26/08/2022 (Shift-III)

**Ans. (c) :** Just as,                      And ,

M	→	N	T	→	G
G	→	T	H	→	S
B	→	Y	K	→	P

Similarly from option (c),

Q	→	J
D	→	W
F	→	U

Hence option (c) is correct.

254. Select the option that is related to the fifth letter-cluster in the same way as the second letter-cluster is related to the first letter-cluster and the fourth letter-cluster is related to the third letter-cluster.

BFHN : HBDI :: DHFM : JDBH :: FSWL : ?

- (a) LOSG (b) KPSH  
(c) KOTF (d) LPSF

**RRB Group-D- 02/09/2022 (Shift-I)**

**Ans. (a) :** Such as,

B	F	H	N
+6↓	-4↓	-4↓	-5↓
H	B	D	I

and,

D	H	F	M
+6↓	-4↓	-4↓	-5↓
J	D	B	H

Hence, ? = LOSG

**255.** In the given letter-cluster pairs, the first letter-cluster is related to the second letter-cluster following a certain logic. Study the given pairs carefully and from the given options, select the pair that follows the same logic.

- AOE : FUJ  
RKT : WQY  
(a) CRU : HXY (b) JPM : OUS  
(c) QEI : VKN (d) DPJ : JUP

**RRB Group-D- 22/09/2022 (Shift-III)**

**Ans.(c) :** Such as,

A	O	E
-5↓	+6↓	+5↓
F	U	J

and,

R	K	T
+5↓	+6↓	+5↓
W	Q	Y

Hence, ? = VKN

**256.** Select the option that is related to the first letter-cluster in the same way as the second letter-cluster is related to the first letter-cluster and the fourth letter-cluster is related to the third letter-cluster.

- EXA : HSH :: LWQ : ORX :: KNO : ?  
(a) NIV (b) MIW  
(c) MIV (d) NHW

**RRB Group-D- 20/09/2022 (Shift-III)**

**Ans. (a) :** Such as,

E	X	A
-3↓	-5↓	+7↓
H	S	H

and,

L	W	Q
-3↓	-5↓	+7↓
O	R	X

Hence, ? = NIV

**257.** In the given letter-cluster pairs, the first letter-cluster is related to the second letter-cluster following a certain logic. Study the given pairs carefully and from the given options, select the pair that follow the same logic.

- DHP : HLT  
MSO : QWS

- (a) WSE : WJO (b) SEW : WOJ  
(c) SEW : WJO (d) SKF : WOJ

**RRB Group-D- 13/09/2022 (Shift-III)**

**Ans. (d) :** Such as,

D	H	P
+4↓	+4↓	+4↓
H	L	T

and,

M	S	O
+4↓	+4↓	+4↓
Q	W	S

Hence, ? = WOJ

**258.** Given below are two letter-cluster pairs in which the second letter-cluster is related to the first letter-cluster following a certain logic. Select the cluster pair from among the options that follows the same logic.

- QTS : WZY  
MPG : SVM  
(a) HKW : BQQ (b) HKW : NQC  
(c) HKW : BEO (d) HKW : NEC

**RRB Group-D- 13/09/2022 (Shift-I)**

**Ans. (b) :** Just as,

Q	-6→	W
T	-6→	Z
S	-6→	Y

and,

M	-6→	S
P	-6→	V
G	-6→	M

Similarly-

H	+6↓	K	+6↓	W
N	+6↓	Q	+6↓	C

**259.** In the given letter-cluster pairs, the first letter-cluster is related to the second letter-cluster following a certain logic. Study the given pair carefully, and from the given options, select the pair that follows the same logic.

- ASD : EWH  
FGH : JKL  
(a) GYU : JCY (b) JKL : NOP  
(c) NSP : ORQ (d) CBH : GFM

**RRB Group-D- 01/09/2022 (Shift-II)**

**Ans. (b) :** Just as,

A	+4→	E
S	+4→	W
D	+4→	II

and

F	+4→	J
G	+4→	K
II	+4→	L

Same as,

J	+4→	N
K	+4→	O
L	+4→	P

**260.** Given below are two letter-cluster pairs in which the second letter-cluster is related to the first letter-cluster following a certain logic. Select the letter-cluster pair from among the options that follows the same logic.

- CPG : PGC  
TJM : JMT



- (a) UQK : QKU (b) UQK : KQU  
 (c) UQK : QKV (d) UQK : QUK

**RRB Group-D- 06/10/2022 (Shift-I)**

**Ans.(a) :** Just as and,  
 C P G : P G C T J M : J M T  
 1 2 3 → 2 3 1 1 2 3 → 2 3 1  
 Same as, From option (a)-  
 U Q K : Q K U  
 1 2 3 → 2 3 1  
 Hence, option (a) is correct.

**261.** In the given letter-cluster pairs, the first letter-cluster is related to the second letter-cluster following a certain logic. Study the given pairs carefully and from the given options, select the pair that follows the same logic.

- ACR : BDS**  
**GUX : HVY**  
 (a) SIO : KQP (b) MQF : NRG  
 (c) OIF : NHE (d) HJL : SQO

**RRB Group-D 11-10-2022 (Shift-II)**

**Ans. (b) :** Just as,  
 A →<sup>+1</sup> B  
 C →<sup>+1</sup> D  
 R →<sup>+1</sup> S  
 and,  
 G →<sup>+1</sup> H  
 U →<sup>+1</sup> V  
 X →<sup>+1</sup> Y  
 Same as,  
 M →<sup>+1</sup> N  
 Q →<sup>+1</sup> R  
 F →<sup>+1</sup> G  
 Hence option (b) is correct.

**262.** In the given letter-cluster pairs, the first letter-cluster is related to the second letter-cluster following a certain logic. Study the given pairs carefully and from the given options, select the pair that following the same logic.

- TSRA : ZIHG**  
**OLEV : EVOL**  
 (a) KVRA : ZIEQ (b) ARNI : RMIZ  
 (c) CRVF : VEIX (d) JPMN : ONKQ

**RRB Group-D 17-09-2022 (Shift-I)**

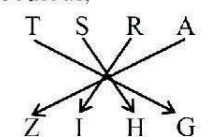
**Ans. (b) :** Just as,  
  
 (Opposite letters)

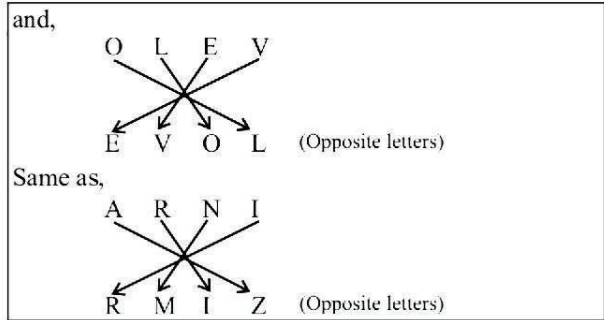

**263.** In the given letter-cluster pairs, the first letter-cluster is related to the second letter-cluster following a certain logic. Study the given pairs carefully and from the given options, select the pair that follows the same logic.

- GKV : IMX**  
**PLR : RNT**  
 (a) UKM : TPJ (b) EMH : VXR  
 (c) WDZ : JAP (d) JWO : LYQ

**RRB Group-D 07-10-2022 (Shift-II)**

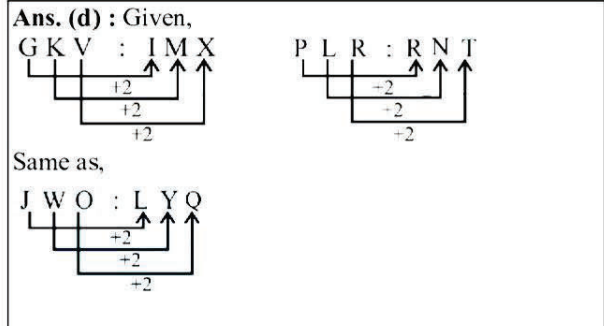

**264.** In the given letter-cluster pairs, the first letter-cluster is related to the second letter-cluster following a certain logic. Study the given pairs carefully and from the given options, select the pair that follows the same logic.

- YRF : UNB**  
**OLS : KHO**  
 (a) OKA : LPZ (b) TDU : GWF  
 (c) MPL : ILH (d) RJM : TSY

**RRB Group-D 07-10-2022 (Shift-I)**

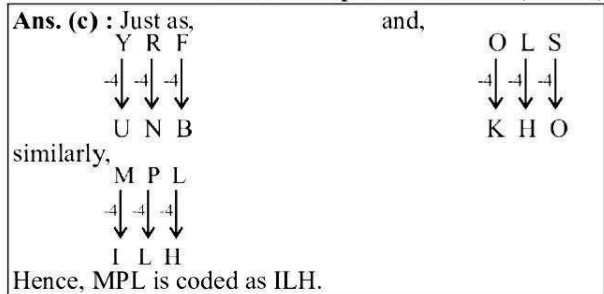

**265.** Select the option that is related to the fifth letter-cluster in the same way as the second letter-cluster is related to the first letter-cluster and the fourth letter-cluster is related to the third letter-cluster.

- BEING : YVRMT : PRIDE : KIRWV :: CLEAN : ?**

- (a) XPVRM                      (b) XOVZM  
(c) XOWZM                      (d) GOVZP

**RRB Group-D 18-08-2022 (Shift-I)**

**Ans. (b) :** Just as,

B	E	I	N	G
↓	↓	↓	↓	↓
Y	V	R	M	T

(Opposite letters)

and,

P	R	I	D	E
↓	↓	↓	↓	↓
K	I	R	W	V

(Opposite letters)

Same as,

C	L	E	A	N
↓	↓	↓	↓	↓
X	O	V	Z	M

(Opposite letters)

- 266.** Select the option that is related to the fifth letter-cluster in the same way as the second letter-cluster is related to the first letter-cluster and the fourth letter-cluster is related to the third letter-cluster.

**SMILE : ELIMS :: MASTE : ETSAM :: STARV : ?**

- (a) SRVAT                      (b) VRATS  
(c) VTARS                      (d) VRTAS

**RRB Group-D 18-08-2022 (Shift-II)**

**Ans. (b) :** Just as, 1 2 3 4 5    5 4 3 2 1

S	M	I	L	E
---	---	---	---	---

→ ELIMS

and, 1 2 3 4 5    5 4 3 2 1

M	A	S	T	E
---	---	---	---	---

→ ETSAM

Same as, 1 2 3 4 5    5 4 3 2 1

S	T	A	R	V
---	---	---	---	---

→ VRATS

- 267.** Select the option that is related to the fifth letter-cluster in the same way as the second letter-cluster is related to the first letter-cluster and the fourth letter-cluster is related to the third letter-cluster.

**PORTUGAL : UTRPOLGA :: URANUS : UUSRNA :: AMRITSAR : ?**

- (a) AATTRSMI                      (b) TRRSMIAA  
(c) TSRRMIAA                      (d) TSMIRRAA

**RRB Group-D 18-08-2022 (Shift-III)**

**Ans. (c) :** Just as,

P O R T U G A L → U T R P O L G A

and,

U R A N U S → U U S R N A

Same as,

A M R I T S A R → T S R R M I A A

All the letters of given words are arranged in descending order.

- 268.** Select the option that is related to the fifth term in the same way as the fourth term is related to the third term and the second term is related to the first term.

**DOLPHIN : ALIMEFK :: GROUP : DOLRM :: SHARK : ?**

- (a) PFXOH                      (b) PEYOH  
(c) VKDUN                      (d) PEXOH

**RRB Group-D 27-09-2022 (Shift-II)**

**Ans. (d) :** Just as,

<p>D <math>\xrightarrow{-3}</math> A</p> <p>O <math>\xrightarrow{-3}</math> L</p> <p>L <math>\xrightarrow{-3}</math> I</p> <p>P <math>\xrightarrow{-3}</math> M</p> <p>H <math>\xrightarrow{-3}</math> E</p> <p>I <math>\xrightarrow{-3}</math> F</p> <p>N <math>\xrightarrow{-3}</math> K</p>	<p>and,</p> <p>G <math>\xrightarrow{-3}</math> D</p> <p>R <math>\xrightarrow{-3}</math> O</p> <p>O <math>\xrightarrow{-3}</math> L</p> <p>U <math>\xrightarrow{-3}</math> R</p> <p>P <math>\xrightarrow{-3}</math> M</p>
--	--

Similarly,

S $\xrightarrow{-3}$	P
H $\xrightarrow{-3}$	
A $\xrightarrow{-3}$	
R $\xrightarrow{-3}$	
K $\xrightarrow{-3}$	

- 269.** Select the option that is related to the fifth letter-cluster in the same way as the second letter-cluster is related to the first letter-cluster and the fourth letter-cluster is related to the third letter-cluster.

**FAKE : GZLD :: CALL : DZMK :: PICK : ?**

- (a) QHBL                      (b) QHBJ  
(c) QHDL                      (d) QHDJ

**RRB Group-D 30-08-2022 (Shift-II)**

**Ans. (d) :** Just as,

<p>F <math>\xrightarrow{+1}</math> G</p> <p>A <math>\xrightarrow{-1}</math> Z</p> <p>K <math>\xrightarrow{+1}</math> L</p> <p>E <math>\xrightarrow{-1}</math> D</p>	<p>and,</p> <p>C <math>\xrightarrow{+1}</math> D</p> <p>A <math>\xrightarrow{-1}</math> Z</p> <p>L <math>\xrightarrow{+1}</math> M</p> <p>L <math>\xrightarrow{-1}</math> K</p>
---	---

Same as,

P $\xrightarrow{+1}$	Q
I $\xrightarrow{-1}$	
C $\xrightarrow{+1}$	
K $\xrightarrow{-1}$	

- 270.** In the given letter-cluster pairs, the first letter-cluster is related to the second letter-cluster following a certain logic. Study the given pairs carefully, and from the given options, select the pair that follows the same logic.



LUN : PXP

WXP : AAR

(a) NIB : RLD

(b) NOT : RQV

(c) TIN : XLQ

(d) JUG : NYJ

RRB Group-D 30-08-2022 (Shift-III)

Ans. (a) : Just as,

L	U	N
+4↓	+3↓	-2↓
P	X	P

and,

W	X	P
+4↓	+3↓	+2↓
A	A	R

Same as, from option (a),

N	I	B
+4↓	+3↓	+2↓
R	L	D

271. In the given letter-cluster pairs, the first letter-cluster is related to the second letter-cluster following a certain logic. Study the given pairs carefully and from the given options, select the pair that follows the same logic.

LINE : MHOD

GOAT : HNBS

(a) TRIP : USJO

(b) PAIR : QZJQ

(c) CLUE : DKVF

(d) JSQB : IPPA

RRB Group-D- 22/09/2022 (Shift-I)

Ans. (b) : Such as,

L	I	N	E
+1↓	-1↓	+1↓	-1↓
M	H	O	D

and,

G	O	A	T
+1↓	-1↓	-1↓	-1↓
H	N	B	S

Hence, ? = QZJQ

Similarly,

P	A	I	R
+1↓	-1↓	+1↓	-1↓
Q	Z	J	Q

272. Select the option that is related to the fifth letter-cluster in the same way as the second letter-cluster is related to the first letter-cluster and the fourth letter-cluster is related to the third letter-cluster.

ALMOST : MLATSO :: BEGINS : GEBSNI :: CHIMPS : ?

(a) IHCPMS

(b) IHCPSM

(c) IHCSMP

(d) IHCSPM

RRB Group-D- 16/09/2022 (Shift-III)

Ans. (d) : Just as,

A	L	M	O	S	T
↙	↘	↙	↘	↙	↘
M	L	A	T	S	O

and,

B	E	G	I	N	S
↙	↘	↙	↘	↙	↘
G	E	B	S	N	I

Hence, : = IHCSPM

273. Select the option that is related to the fifth letter-cluster in the same way as the second letter-cluster is related to the first letter-cluster and the fourth letter-cluster is related to the third letter-cluster.

NALAYAK : KAYALAN :: BEAUTY : YTUAEB :: POWERTY : ?

(a) TPWEROY

(b) WOPREYT

(c) YTREWOP

(d) YRTEWOP

RRB Group-D- 26/08/2022 (Shift-III)

Ans.(c) : Such as,

NALAYAK → KAYALAN

and,

BEAUTY → YTUAEB

Similarly,

POWERTY → YTREWOP

Note → Reversing the letter of word.

274. Select the option that is related to the fifth letter-cluster in the same way as the second letter-cluster is related to the first letter-cluster and the fourth letter-cluster is related to the third letter-cluster.

SEVERAL : MZSDWDT :: TRACKED : EDLBBQU

(a) HMICBDJ

(b) IDBCJMH

(c) JDBCIMH

(d) HMJCBDI

RRB NTPC (Stage-II) -15/06/2022 (Shift-II)

Ans. (d) : Just as,

S	E	V	E	R	A	L	M	Z	S	D	W	D	T
↑	↑	↑	↑	↑	↑	↑	↑	↑	↑	↑	↑	↑	↑
-1	-1	-1	-1	-1	-1	-1	-1	-1	-1	-1	-1	-1	-1
↑	↑	↑	↑	↑	↑	↑	↑	↑	↑	↑	↑	↑	↑
+1	+1	+1	+1	+1	+1	+1	+1	+1	+1	+1	+1	+1	+1

and,

T	R	A	C	K	E	D	E	D	L	B	B	Q	U
↑	↑	↑	↑	↑	↑	↑	↑	↑	↑	↑	↑	↑	↑
-1	-1	-1	-1	-1	-1	-1	-1	-1	-1	-1	-1	-1	-1
↑	↑	↑	↑	↑	↑	↑	↑	↑	↑	↑	↑	↑	↑
+1	+1	+1	+1	+1	+1	+1	+1	+1	+1	+1	+1	+1	+1

Same as,



H	E	A	D	I	N	G	H	M	J	C	B	D	I
↑	↑	↑	↑	↑	↑	↑	↑	↑	↑	↑	↑	↑	↑
-1	-1	-1	-1	-1	-1	-1	-1	-1	-1	-1	-1	-1	-1
↑	↑	↑	↑	↑	↑	↑	↑	↑	↑	↑	↑	↑	↑
+1	+1	+1	+1	+1	+1	+1	+1	+1	+1	+1	+1	+1	+1

275. Select the option that is related to the fifth letter-cluster in the same way as the second letter-cluster is related to the first letter-cluster and the fourth letter-cluster is related to the third letter-cluster.

PROFESS : ORPSSEF :: CONTAIN : NOCNIAT :: ROUTINE : ?

- (a) UROEINT (b) TORENIU  
(c) UORNETI (d) UORENIT

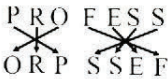
**RRB Group-D- 02/09/2022 (Shift-III)**

**Ans. (d) :** Such as,  
  
 and  
  
 Hence ? = UORENIT

276. In the given letter-cluster pairs, the first letter-cluster is related to the second letter-cluster following a certain logic. Study the given pairs carefully, and from the given options, select the pair that follows the same logic.

**COWBOY : WOCYOB**

**TANGLE : NATELG**

- (a) FLOWER : OLFREW  
(b) CROWDS : ORDWSC  
(c) MANGLE : NMALEG  
(d) PICKLE : CIPLKE

**RRB Group-D- 17/08/2022 (Shift-II)**

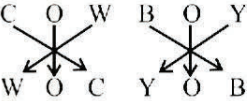
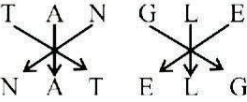
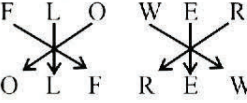

**Ans. (a) :** Given,  
  
 and,  
  
 Same as,  
 From option (a)-  
  
 Hence, option 'a' is correct.

277. Select the option that is related to the fifth term in the same way as the fourth term is related to the third term and the second term is related to the first term.

**MOTHER : OMHTRE :: DAUGHTER : ADGUTHRE :: SIBLINGS :**

- (a) BISNILSG (b) ISLBNISG  
(c) SGNILBIS (d) LIBSSGNI

**RRB Group-D- 22/09/2022 (Shift-II)**

**Ans. (b) :** Such as,  
  
 and  

Similar  
  
 Hence, ? = ISLBNISG

278. Select the option that is related to the third term in the same way as the second term is related to the first term.

**BOWL : DMYJ :: PLATE : ?**

- (a) JRCGV (b) RJCRCG  
(c) NNYVC (d) RNCVG

**RRB NTPC 31.07.2021 (Shift-I) Stage Ist**

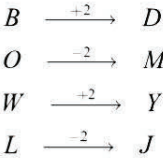
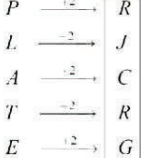
**Ans. (b) :** Just as,  
  
 Same as,  
  
 Hence, ? = RJCRCG

279. Select the option that is related to the third term in the same way as the second term is related to the first term :

**DFHJ : EHKJ :: OQSU : ?**

- (a) PSVY (b) PQUY  
(c) PRVY (d) PRVX

**RRB NTPC 10.01.2021 (Shift-I) Stage Ist**

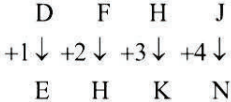
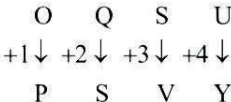
**Ans. (a) :** Just as,  
  
 Same as,  

280. Which of the following would best complete the relation given below?

**AFI : M :: ABA : ?**

- (a) K (b) O  
(c) L (d) J

**RRB JE - 01/06/2019 (Shift-III)**

**Ans. (a) Just as**  
 $AFI = M$   
 $169 = 13^2$   
 Same as,  
 $ABA = \boxed{K}$   
 $121 = 11^2$

281. Select the option that is related to the third term in the same way as the second term is related to the first term.

**BOWL : DMYJ :: PLATE : ?**

- (a) JRCGV (b) RJCRCG  
(c) NNYVC (d) RNCVG

**RRB NTPC 31.07.2021 (Shift-I) Stage Ist**



**Ans. (b) :** Just as,

$B \xrightarrow{-2} D$   
 $O \xrightarrow{-2} M$   
 $W \xrightarrow{-2} Y$   
 $L \xrightarrow{-2} J$

Same as,

$P \xrightarrow{+2} R$   
 $L \xrightarrow{-2} J$   
 $A \xrightarrow{+2} C$   
 $T \xrightarrow{-2} R$   
 $E \xrightarrow{-2} G$

Hence, ? = RJCRG

**182.** Select the option that is related to the third term in the same way as the second term is related to the first term :

**DFHJ : EHKN :: OQSU : ?**

- (a) PSVY (b) PQUY  
 (c) PRVY (d) PRVX

**RRB NTPC 10.01.2021 (Shift-I) Stage Ist**

**Ans. (a) :** Just as,

D F H J  
 $+1 \downarrow +2 \downarrow +3 \downarrow +4 \downarrow$   
 E H K N

Same as,

O Q S U  
 $+1 \downarrow +2 \downarrow +3 \downarrow +4 \downarrow$   
P S V Y

**283.** Select the option that is related to the third letter-cluster in the same way as the second letter-cluster is related to the first letter-cluster.

**RAM : PBO :: SPQ : ?**

- (a) QQR (b) QQT  
 (c) QPS (d) QQS

**RRB NTPC 14.03.2021 (Shift-II) Stage Ist**

**Ans. (d) :** Just as, Same as,  
 $R \ A \ M$   $S \ P \ Q$   
 $-2 \downarrow -1 \downarrow +2 \downarrow$   $-2 \downarrow +1 \downarrow +2 \downarrow$   
 $P \ B \ O$   $Q \ Q \ S$

Therefore option (d) is correct.

**284.** Select the letter-cluster that can replace the question mark (?) in the following analogy.

**YLP : KOB :: BUS : HFY :: RAN : ?**

- (a) MZI (b) NSX  
 (c) PYD (d) LGR

**RRB NTPC 14.03.2021 (Shift-I) Stage Ist**

**Ans. (a) :** Just as,

$Y \xrightarrow{\text{Opposite}} B$   
 $L \xrightarrow{\text{Opposite}} O$   
 $P \xrightarrow{\text{Opposite}} K$

Same as,

$R \xrightarrow{\text{Opposite}} I$   
 $A \xrightarrow{\text{Opposite}} Z$   
 $N \xrightarrow{\text{Opposite}} M$

And,

$B \xrightarrow{\text{Opposite}} Y$   
 $U \xrightarrow{\text{Opposite}} F$   
 $S \xrightarrow{\text{Opposite}} H$

Hence, the answer will be RAN : MZI.

**285.** HJP is related to 'KMS' in the same way as 'CDA' is related to \_\_\_\_\_

- (a) EFC (b) FHE  
 (c) GHE (d) FGD

**RRB NTPC 01.04.2021 (Shift-II) Stage Ist**

**Ans. (d) :** Just as,

H J P  $\xrightarrow{+3}$  K M S  
 $\xrightarrow{+13}$   
 $\xrightarrow{+3}$

Similarly,

C D A  $\xrightarrow{+3}$  F G D  
 $\xrightarrow{+3}$   
 $\xrightarrow{+13}$

Hence, option (d) is correct.

**286.** In a certain code language, ALIGATOR is written as LAROGITA. How will COMPUTER be written as in that language?

- (a) PMOCRETU (b) OCREPMTU  
 (c) OCPMTURE (d) RETUPMOC

**RRB NTPC 06.04.2021 (Shift-I) Stage Ist**

**Ans. (b) :** Just as,

A L I G A T O R  $\rightarrow$  L A R O G I T A  
 1 2 3 4 5 6 7 8      2 1 8 7 4 3 6 5

Same As,

C O M P U T E R  $\rightarrow$  O C R E P M T U  
 1 2 3 4 5 6 7 8      2 1 8 7 4 3 6 5

**287.** Select the option that is related to the third letter cluster in the same way as the second letter cluster is related to the first letter cluster.

**RAMO : SCPS :: VXMJ : ?**

- (a) WQZN (b) WQPN  
 (c) WPZN (d) WZPN

**RRB NTPC 28.12.2020 (Shift-I) Stage Ist**

**Ans. (d) :**

Just as,  
 $R \xrightarrow{+1} S$   
 $A \xrightarrow{+2} C$   
 $M \xrightarrow{+3} P$   
 $O \xrightarrow{+4} S$

Same as,  
 $V \xrightarrow{+1} W$   
 $X \xrightarrow{+2} Z$   
 $M \xrightarrow{+3} P$   
 $J \xrightarrow{+4} N$

Hence, ? = WZPN

288. Select the option that is related to the third term in the same way as the second term is related to the first term.

- BLCM : FHGI = KHWS : ?**  
 (a) ODAO (b) OLAW  
 (c) ODSO (d) OLSO

RRB NTPC 11.01.2021 (Shift-I) Stage Ist

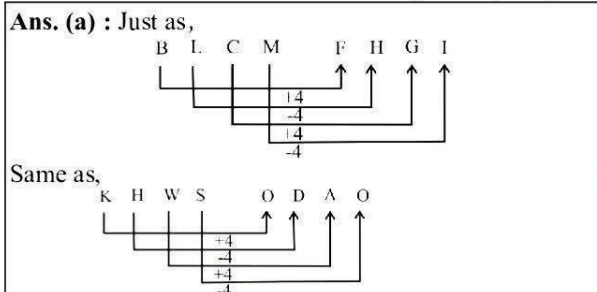

289. Select the letter that can replace the question mark (?) in the following series.

**C : X :: D : ?**

- (a) X (b) W  
 (c) U (d) V

RRB NTPC 16.02.2021 (Shift-II) Stage Ist

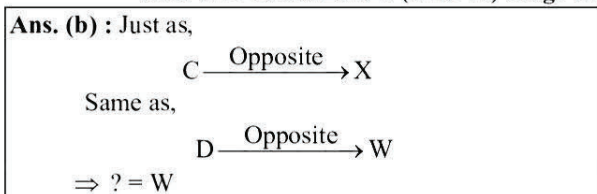

290. Select the option that is related to the third letter cluster in the same way as the second letter cluster is related to the first term.

**KOPT : AEFJ :: QUVZ : ?**

- (a) NRSW (b) PTUY  
 (c) GKLP (d) OSTX

RRB NTPC 29.12.2020 (Shift-II) Stage Ist

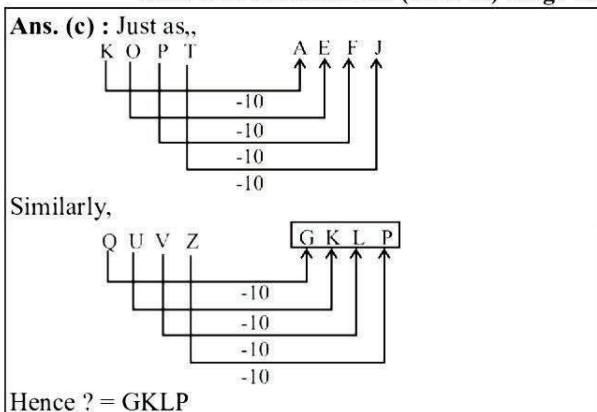

291. Identify the letter-pair from among the given options that expresses a relationship most similar to that expressed in the following letter-pairs.

**yb, ve, tg, ?**

- (a) jl (b) pk  
 (c) ms (d) ot

RRB NTPC 17.01.2021 (Shift-II) Stage Ist

Ans. (b) : Just as,

- y — Opposite letter → b  
 v — Opposite letter → e  
 t — Opposite letter → g

Same as from option (b).

- p — Opposite letter → k

292. Select the option that is related to the third letter-cluster in the same way as the second letter-cluster is related to the first letter-cluster.

**ACEG : PRTV :: SUWY : ?**

- (a) HFDB (b) GIKM  
 (c) HJLN (d) HKLM

RRB NTPC 15.03.2021 (Shift-I) Stage Ist

Ans. (c) : Just as,

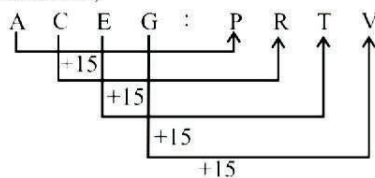

Similarly,

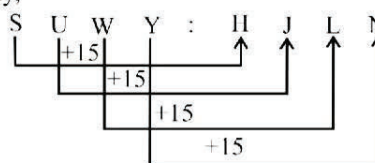

Hence, ? = HJLN

293. Select the option that is related to the third letter-cluster in the same way as the second letter-cluster is related to the first letter-cluster.

**MNTK : HIOF :: RUNA : ?**

- (a) MPJV (b) VZSF  
 (c) MPIV (d) NPIU

RRB NTPC 30.12.2020 (Shift-II) Stage Ist

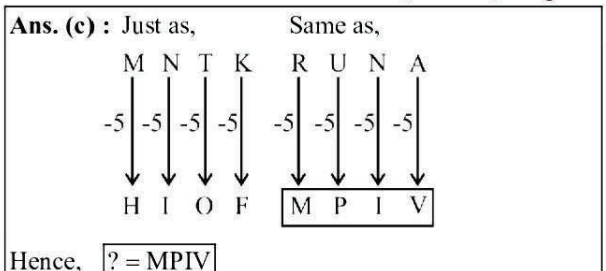

294. Select the letter-cluster from among the given options that can replace the question mark (?) in the following series.

**CJ, FM, ?, LS, OV**

- (a) HL (b) IP  
 (c) RX (d) KQ

RRB NTPC 10.01.2021 (Shift-II) Stage Ist



Ans. (b) : The series is as follows-

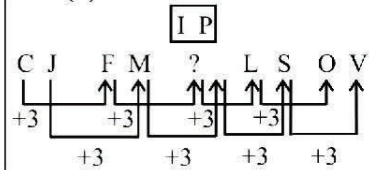

Hence,  $\boxed{? = IP}$

295. Select the option in which the terms share the same relationship as that shared by the given pair of terms.

**DMO : WNL**

- (a) CFH : XUT                      (b) ZAT : EGD  
(c) DQG : ELP                      (d) GHI : TSR

RRB NTPC 02.02.2021 (Shift-I) Stage Ist

Ans. (d) : Just as,

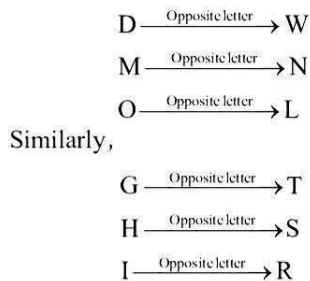

296. Select the option that is related to the third term in the same way as the second term is related to the first term.

**FEAL : LEAF :: EAKT : ?**

- (a) ETAK                              (b) KETA  
(c) KATE                              (d) TAKE

RRB NTPC 23.01.2021 (Shift-I) Stage Ist

Ans. (d) :

Just as,

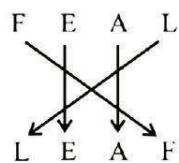

Similarly



Hence  $\boxed{? = TAKE}$

297. Select the letter that can replace the question mark (?) in given series.

**B : H :: P : V :: N : ?**

- (a) T                                      (b) P  
(c) M                                      (d) K

RRB NTPC 11.03.2021 (Shift-II) Stage Ist

Ans. (a) : Given series is as follows-

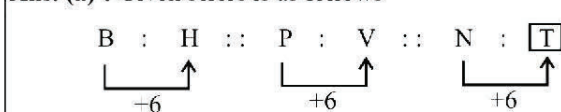

Hence,  $\boxed{? = T}$

298. Choose the pair from the given option that are related like the words of the first pair.

**PALE : LEAP :: POSH : .....**

- (a) HSPO                              (b) HSOP  
(c) POHS                              (d) SHOP

RRB NTPC 19.01.2017 Shift : I

Ans. (d) : Just as,

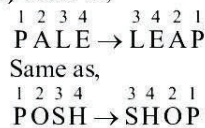

299. Choose the pair from the given option that are related like the words of the first pair.

**ACE : FHJ :: OQS : .....**

- (a) TVX                                      (b) PRS  
(c) TXV                                      (d) RPS

RRB NTPC 19.01.2017 Shift : I

Ans. (a) : Just as,

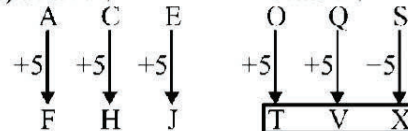

300. Complete the code.

**CD : GA :: PQ : ?**

- (a) SM                                      (b) SN  
(c) US                                      (d) TN

RRB NTPC 17.01.2017 Shift-II

Ans. (d) : Just as,



301. Select the missing term based on the given related pair of letter clusters.

**ABC : ZYX :: DEF : .....**

- (a) VUW                                      (b) UVW  
(c) WUV                                      (d) WVU

RRB ALP & Tec. (17-08-18 Shift-III)

Ans : (d) Just as,

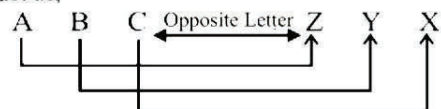

Similarly,

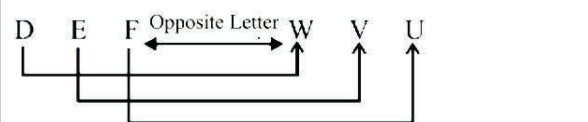

302. Select the related letters from the Given alternatives:

**PUNE : SXQF :: CITY : .....**

- (a) FLXZ                                      (b) EKVZ  
(c) GMVZ                                      (d) FLWZ

RRB ALP & Tec. (14-08-18 Shift-II)

Ans. (d) : Just as,

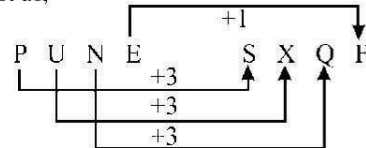

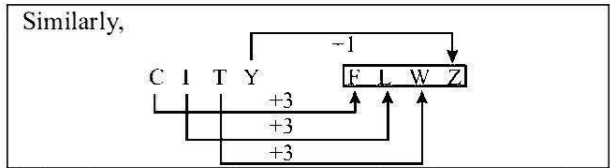

303. Select the missing term based on the given related pair of letter clusters.  
**BFK : IMR :: DGP : .....**  
 (a) KWN (b) KNW  
 (c) KNZ (d) WNK

RRB ALP & Tec. (20-08-18 Shift-I)

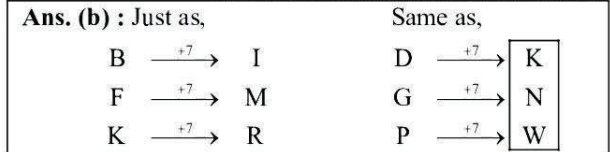

304. Find the missing term for the related pair of letter clusters.  
**RAMA : MARA :: SITA :: .....**  
 (a) TSAI (b) TIAS  
 (c) SIAT (d) TISA

RRB ALP & Tec. (17-08-18 Shift-I)

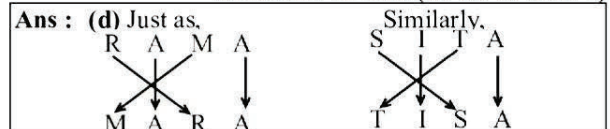

305. Select the missing term from the related pair of letter clusters:  
**BEAK : EIFQ :: SAIL : .....**  
 (a) RENV (b) VREN  
 (c) VERN (d) VERN

RRB ALP & Tec. (17-08-18 Shift-I)

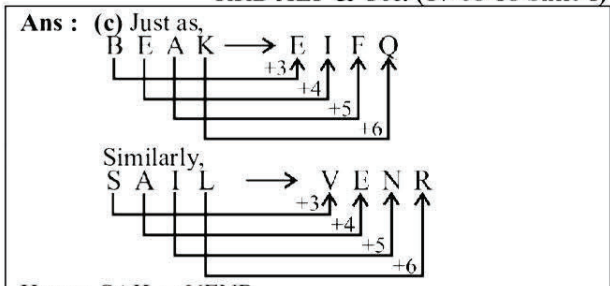

306. Select the related letters from the given alternatives:  
**VMR : ZIS :: AKT : .....**  
 (a) HIR (b) EOU  
 (c) FHS (d) EGU

RRB ALP & Tec. (30-08-18 Shift-I)

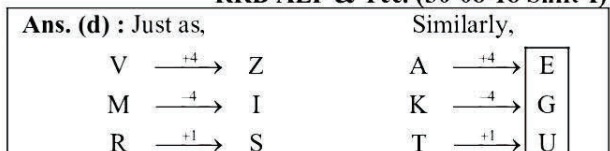

307. Which of the following would best complete the relation given below?  
**RAT : SDY :: BAD : ?**  
 (a) CDI (b) BFL  
 (c) LFB (d) DCI

RRB JE - 31/05/2019 (Shift-III)

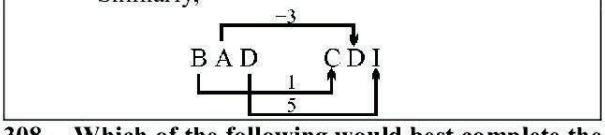
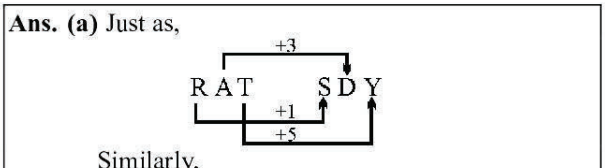

308. Which of the following would best complete the relation given below?  
**BFIJ : DHKL :: LOQT : ?**  
 (a) NVSQ (b) NQSV  
 (c) NQVS (d) NSQV

RPF Constable 22.01.2019 Shift : III

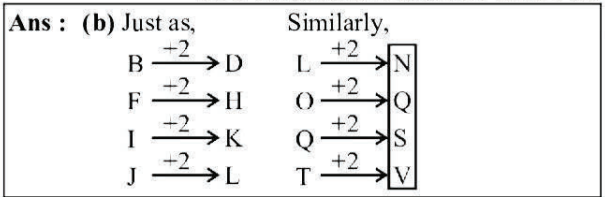

309. Which of the following would best complete the relation given below?  
**MOQ : STW :: ACE : ?**  
 (a) KIH (b) HKG  
 (c) HIK (d) GHK

RRB JE - 27/05/2019 (Shift-II)

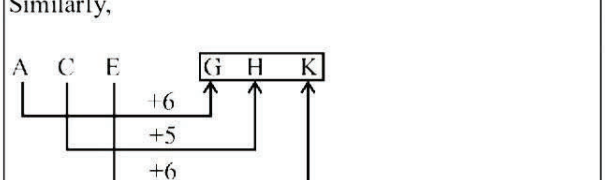
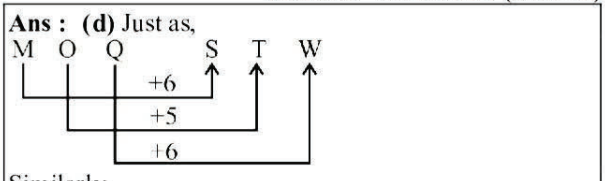

310. Which of the following would best complete the relation given below?  
**ZYX : PQR :: XYZ : ?**  
 (a) PRQ (b) QRP  
 (c) RQP (d) YZX

RRB JE - 27/05/2019 (Shift-III)

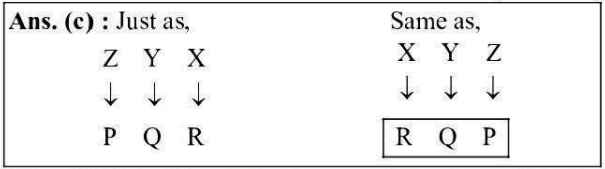

311. Which of the following would best complete the relation given below?  
**TEF : UGH :: KPQ : ?**  
 (a) LSR (b) LRS  
 (c) RSL (d) NRS

RRB JE - 27/05/2019 (Shift-I)



**Ans. (b) :** Just as,

Similarly,

So, **? = LRS**

312. Which word would best complete the relation given below?  
**BH : JP :: FK : ?**  
 (a) NT (b) MS  
 (c) OT (d) NS

RRB JE - 30/05/2019 (Shift-II)

**Ans. (d) :** Just as,

Same as,

313. Which of the following would best complete the relation given below?  
**RPM : IGD :: XVS : ?**  
 (a) ILN (b) OMJ  
 (c) NIL (d) JMO

RRB JE - 29/05/2019 (Shift-I)

**Ans. (b) :** Just as, Same as,

R $\xrightarrow{-9}$ I	X $\xrightarrow{-9}$ O
P $\xrightarrow{-9}$ G	V $\xrightarrow{-9}$ M
M $\xrightarrow{-9}$ D	S $\xrightarrow{-9}$ J

314. Which of the following would best complete the relation given below?  
**ACEG : KMOQ :: IKMO : ?**  
 (a) SUWZ (b) STUV  
 (c) SVWY (d) SUWY

RRB JE - 28/05/2019 (Shift-II)

**Ans. (d) :** Just as, Same as,

A $\xrightarrow{+10}$ K	I $\xrightarrow{+10}$ S
C $\xrightarrow{+10}$ M	K $\xrightarrow{+10}$ U
E $\xrightarrow{+10}$ O	M $\xrightarrow{+10}$ W
G $\xrightarrow{+10}$ Q	O $\xrightarrow{+10}$ Y

315. Which of the following would best complete the relation given below?  
**FDA : MKH :: QOL : ?**  
 (a) QUZ (b) XVS  
 (c) SVX (d) XSV

RPF SI 12.01.2019 Shift : I

**Ans. (b) :** Just as, Same as,

F $\xrightarrow{+7}$ M	Q $\xrightarrow{+7}$ X
D $\xrightarrow{+7}$ K	O $\xrightarrow{+7}$ V
A $\xrightarrow{+7}$ H	L $\xrightarrow{+7}$ S

316. Which of the following would best complete the relation given below?  
**BPC : CQD :: RIS : ?**  
 (a) SKT (b) TJS  
 (c) TKS (d) SJT

RRB JE - 26/05/2019 (Shift-II)

**Ans. (d) :** Just as,

Similarly,

317. Select the pair that represents the same relation as the pair given below.  
**ABD : EGH**  
 (a) IKL : NRT (b) OPR : UTY  
 (c) IJL : MOP (d) GFH : IPR

RRB JE - 01/06/2019 (Shift-III)

**Ans. (c) :** Just as,

Similarly,

318. Find the missing term in this series  
**EARTH : HDUWK :: VENUS : \_\_\_\_\_?**  
 (a) YQH VX (b) YQH XV  
 (c) YQXHV (d) YHQXV

RRB Group-D - 05/11/2018 (Shift-III)

**Ans. (d) :** Just as, Same as,

E $\xrightarrow{+3}$ H	V $\xrightarrow{-3}$ Y
A $\xrightarrow{+3}$ D	E $\xrightarrow{+3}$ H
R $\xrightarrow{+3}$ U	N $\xrightarrow{+3}$ Q
T $\xrightarrow{+3}$ W	U $\xrightarrow{+3}$ X
H $\xrightarrow{-3}$ K	S $\xrightarrow{+3}$ V

So, missing term will be YHQXV.

## Type - 4

319. Select the option that is related to the fifth number in the same way as the second number is related to the first number and the fourth number is related to the third number.  
**3 : 25 :: 7 : 81 :: 11 : ?**  
 (a) 144 (b) 169  
 (c) 121 (d) 196

RRB Group-D 24-08-2022 (Shift-II)

Ans. (b) : Just as,

$$3 : 25 \rightarrow (5)^2 \rightarrow 25$$

+2

And,

$$7 : 81 \rightarrow (9)^2 \rightarrow 81$$

+2

Same as,

$$11 : ? \rightarrow (13)^2 \rightarrow 169$$

+2

Hence,  $? = 169$

320. Select the set in which the numbers are related in the same way as are the numbers of the following sets.

(NOTE: Operations should be performed on the whole numbers, without breaking down the numbers into its constituent digits. E.g. 13 – Operations on 13 such as adding/subtracting/multiplying etc. to 13 can be performed.

Breaking down 13 into 1 and 3 and then performing mathematical operations on 1 and 3 is not allowed)

(17, 238, 7)

(23, 414, 9)

(a) (27, 270, 5)

(b) (15, 225, 15)

(c) (13, 273, 7)

(d) (19, 360, 9)

RRB Group-D 27-09-2022 (Shift-III)

Ans. (a) : Just as -

$$(17, 238, 7) \Rightarrow 17 \times (7 \times 2) = 238$$

$$17 \times 14 = 238$$

and,

$$(23, 414, 9) \Rightarrow 23 \times (9 \times 2) = 414$$

$$23 \times 18 = 414$$

From option (a)

Same as -

$$(27, 270, 5) \Rightarrow 27 \times (5 \times 2) = 270$$

$$27 \times 10 = 270$$

321. Select the set in which the numbers are related in the same way as are the numbers of the following sets.

(NOTE: Operations should be performed on the whole numbers, without breaking down the numbers into its constituent digits. EXAMPLE: 13 – Operations on 13 such as adding/subtracting/multiplying etc. to 13 can be performed Breaking down 13 into 1 and 3 and then performing mathematical operations on 1 and 3 is not allowed)

(11, 117, 2)

(9, 56, 5)

(a) (12, 108, 6)

(b) (13, 169, 2)

(c) (7, 46, 1)

(d) (10, 98, 2)

RRB Group-D 27-09-2022 (Shift-III)

Ans. (a) : Just as -

$$(11, 117, 2) \Rightarrow (11+2) \times (11-2)$$

$$= 13 \times 9 = 117 \text{ (Mid Number)}$$

and,

$$(9, 56, 5) \Rightarrow (9+5) \times (9-5)$$

$$= 14 \times 4 = 56 \text{ (Mid Number)}$$

From option (a),

Same as,

$$(12, 108, 6) \Rightarrow (12+6) \times (12-6)$$

$$= 18 \times 6 = 108 \text{ (Mid Number)}$$

322. Select the set in which the numbers are related in the same way as are the numbers of the following sets. (NOTE: Operations should be performed on the whole numbers, without breaking down the numbers into its constituent digits. E.g. 13 – Operations on 13 such as adding/subtracting/multiplying etc. to 13 can be performed. Breaking down 13 into 1 and 3 and then performing mathematical operations of 1 and 3 is not allowed.)

(11, 24, 57) (7, 39, 60)

(a) (17, 58, 91)

(b) (14, 25, 43)

(c) (12, 55, 19)

(d) (15, 41, 86)

RRB Group-D 27-09-2022 (Shift-II)

Ans. (d) : Just as,

$$(11, 24, 57)$$

$$\Rightarrow 11 \times 3 + 24 = 57$$

and,

$$(7, 39, 60)$$

$$\Rightarrow 7 \times 3 + 39 = 60$$

Similarly from option (d),

$$(15, 41, 86)$$

$$\Rightarrow 15 \times 3 + 41 = 86$$

323. Select the set in which the numbers are related in the same way as are the numbers of the following sets.

Note:-Operations should be performed on the whole numbers, without breaking down the numbers into its constituent digits. E.g. 13 – Operations on 13 such as adding / subtracting/multiplying etc. to 13 can be performed breaking down 13 into 1 and 3 then performing mathematical operations on 1 and 3 is not allowed)

(12, 112, 9)

(6, 28, 4)

(a) (12, 149, 12)

(b) (18, 94, 5)

(c) (13, 55, 4)

(d) (11, 99, 9)

RRB Group-D 30-08-2022 (Shift-I)

Ans. (b) : Just as,

$$(12 \times 9) + 4 = 112$$

And,

$$(6 \times 4) + 4 = 28$$

Same as from option (b),

$$(18 \times 5) + 4 = 94$$

Hence, option (b) is correct.



324. Select the set in which the numbers are related in the same way as are the numbers of the given sets.

(NOTE: Operations should be performed on the whole numbers, without breaking down the numbers into its constituent digits, E.g. 13 – operations on 13 such as adding/subtracting/multiplying etc. to 13 can be performed. breaking down 13 into 1 and 3 and then performing mathematical operations on 1 and 3 is not allowed)

(1, 6, 4)

(3, 15, 9)

(a) (10, 33, 11)

(b) (3, 18, 8)

(c) (9, 25, 7)

(d) (2, 16, 8)

RRB Group-D 28-09-2022 (Shift-III)

Ans. (c) : Just as,

$$(1, 6, 4) \rightarrow 1 \times 2 + 4$$

$$= 6 \text{ (middle number)}$$

And,

$$(3, 15, 9) \rightarrow 3 \times 2 + 9$$

$$= 15 \text{ (middle number)}$$

Similarly form option (c),

$$(9, 25, 7) \rightarrow 9 \times 2 + 7$$

$$= 25 \text{ (middle number)}$$

325. Select the option that is related to the third term in the same way as the second term is related to the first term and the sixth term is related to the fifth term.

$$20 : 30 :: 42 : ? :: 72 : 90$$

(a) 55

(b) 51

(c) 52

(d) 56

RRB Group-D 28-09-2022 (Shift-II)

Ans. (d) : Just as,

$$20 : 30$$

$$\downarrow$$

$$4 \times 5$$

And,

$$72 : 90$$

$$\downarrow$$

$$8 \times 9$$

Similarly,

$$42 : \boxed{56}$$

$$\downarrow$$

$$6 \times 7$$

Hence,  $\boxed{? = 56}$

326. Select the set in which the numbers are related in the same way as are the numbers of the following sets.

(NOTE:- Operation should be performed on the whole numbers, without breaking down the numbers into its constituent digits. E.g. 13 – Operations on 13 such as adding/subtracting/multiplying etc. to 13 can be performed. Breaking down 13 into 1 and 3 and then performing mathematical operations on 1 and 3 is not allowed)

(24, 42)

(36, 63)

(a) 52, 91

(b) 40, 82

(c) 48, 96

(d) 36, 91

RRB Group-D 28-09-2022 (Shift-I)

Ans. (a) : Just as,

$$(24, 42) \Rightarrow \begin{array}{cc} 24 & 42 \\ \downarrow & \downarrow \\ 6 \times 4 & 6 \times 7 \end{array}$$

and,

$$(36, 63) \Rightarrow \begin{array}{cc} 36 & 63 \\ \downarrow & \downarrow \\ 9 \times 4 & 9 \times 7 \end{array}$$

Same as from option (a),

$$(52, 91) \Rightarrow \begin{array}{cc} \boxed{52} & \boxed{91} \\ \downarrow & \downarrow \\ 13 \times 4 & 13 \times 7 \end{array}$$

Hence, option (a) is correct.

327. Select the set in which the numbers are related in the same way as are the numbers of the of the following sets.

(Note- Operations should be performed on the whole numbers, without breaking down the numbers into its constituent digits, E.g. 13- Operations on 13 such as adding / deleting / multiplying etc. to 13 can be performed. Breaking down 13 into 1 and 3 then performing mathematical operations on 1 and 3 is not allowed)

(2, 4, 18)

(4, 6, 50)

(a) (6, 7, 65)

(b) (3, 5, 32)

(c) (5, 4, 18)

(d) (2, 5, 49)

RRB Group-D 24-08-2022 (Shift-III)

Ans. (b) : Such as,

$$(2, 4, 18) \rightarrow (2)^2 + (4)^2 - 2 = 20 - 2 = 18$$

and,

$$(4, 6, 50) \rightarrow (4)^2 + (6)^2 - 2 = 52 - 2 = 50$$

Similarly,

$$(3, 5, 32) \rightarrow (3)^2 + (5)^2 - 2 = 34 - 2 = 32$$

328. Select the option that is related to the fifth number in the same way as the second number is related to the first number and the fourth number is related to the third number.

$$27 : 140 :: 22 : 115 :: 32 : ?$$

(a) 155

(b) 165

(c) 130

(d) 140

RRB Group-D 24-08-2022 (Shift-III)

Ans. (b) : Such as,

$$27 : 140 \rightarrow 27 \times 5 + 5 = 140$$

and,

$$22 : 115 \rightarrow 22 \times 5 + 5 = 115$$

Similarly,

$$32 : ? \rightarrow 32 \times 5 + 5 = ?$$

$$? = 160 + 5 = 165$$

329. Select the option that is related to the fifth number in the same way as the second number is related to the first number and the fourth number is related to the third number.

$$8 : 67 :: 10 : 103 :: 17 : ?$$

- (a) 312 (b) 292  
(c) 145 (d) 192

RRB Group-D 24-08-2022 (Shift-II)

Ans. (b) : Such as,

$$8 : 67 \rightarrow (8)^2 + 3 = 67$$

and,

$$10 : 103 \rightarrow (10)^2 + 3 = 103$$

Same as,

$$17 : 292 \rightarrow ?$$

$$(17)^2 + 3 = 292$$

330. Select the set in which the numbers are related in the same way as are the numbers of the following sets.

(NOTE: Operations should be performed on the whole numbers, without breaking down the numbers into its constituent digits. E.g. 13 - Operations on 13 such as adding/deleting/multiplying etc. to 13 can be performed. Breaking down 13 into 1 and 3 and then performing mathematical operations on 1 and 3 is not allowed)

(4, 3, 16)

(3, 5, 19)

- (a) (8, 2, 20) (b) (8, 1, 18)  
(c) (5, 2, 49) (d) (3, 2, 12)

RRB Group-D 23-08-2022 (Shift-I)

Ans. (a) : Just as, (4, 3, 16)  $\rightarrow 4 \times 3 + 4 = 16$

and,

$$(3, 5, 19) \rightarrow 3 \times 5 + 4 = 19$$

Same as,

$$(8, 2, 20) \rightarrow 8 \times 2 + 4 = 20$$

331. Select the set in which the numbers are related in the same way as the numbers of the following sets.

(NOTE : Operations should be performed on the whole numbers, without breaking down the numbers into its constituent digits. E.g. 13 - Operations on 13 such as adding/subtracting/multiplying etc. to 13 can be performed. Breaking down 13 into 1 and 3 and then performing mathematical operations on 1 and 3 are not allowed.)

(7, 175, 5)

(6, 294, 7)

- (a) (5, 140, 7) (b) (3, 192, 8)  
(c) (6, 216, 5) (d) (8, 412, 9)

RRB Group-D 23-08-2022 (Shift-I)

Ans. (b) : Just as,

$$(7, 175, 5) \Rightarrow (5)^2 \times 7 = 25 \times 7 = 175$$

and,

$$(6, 294, 7) \Rightarrow (7)^2 \times 6 = 49 \times 6 = 294$$

Same as,

$$(3, 192, 8) \Rightarrow (8)^2 \times 3 = 64 \times 3 = 192$$

332. Select the option that is related to the fifth number in the same way as the second number is related to the first number and the fourth number is related to the third number.

$$14 : 203 :: 16 : 264 : 18 : ?$$

- (a) 347 (b) 423  
(c) 333 (d) 353

RRB Group-D 23-08-2022 (Shift-II)

Ans. (c) : Given,

$$\begin{array}{ccccccc} 14 & : & 203 & : & 16 & : & 264 & : & 18 & : & ? = 333 \\ \uparrow & & \uparrow & & \uparrow & & \uparrow & & \uparrow & & \uparrow \\ (14)^2 + 7 & & (16)^2 + 8 & & (18)^2 + 9 & & & & & & \end{array}$$

Hence, option (c) is correct answer.

333. Select the option that is related to the fifth number in the same way as the second number is related to the first number and the fourth number is related to the third number.

$$20 : 42 :: 25 : 52 :: 18 : ?$$

- (a) 38 (b) 34  
(c) 60 (d) 54

RRB Group-D 23-08-2022 (Shift-II)

Ans. (a) : Given,

$$\begin{array}{ccccccc} 20 & : & 42 & :: & 25 & : & 52 & :: & 18 & : & ? = 38 \\ \uparrow & & \uparrow & & \uparrow & & \uparrow & & \uparrow & & \uparrow \\ 20 \times 2 + 2 & & 25 \times 2 + 2 & & 18 \times 2 + 2 & & & & & & \end{array}$$

334. In each of the given number-clusters. The number on the right side of '=' (the equal to sign) is calculated by performing certain mathematical operations on the three numbers on the left of '=' (the equal to sign). All three number-clusters follow the same pattern. Select the number from among the given options that can replace the question mark (?) in the third number-cluster.

$$21, 9, 40 = 149$$

$$18, 7, 25 = 101$$

$$15, 11, 30 = ?$$

- (a) 110 (b) 135  
(c) 125 (d) 120

RRB NTPC (Stage-II) -12/06/2022 Shift-I

Ans. (b) : Just as,

$$(i) \quad 21, 9, 40 = 149$$

$$\Rightarrow 21 \times 9 - 40$$

$$189 - 40 = \boxed{149}$$

and,

$$(ii) \quad 18, 7, 25 = 101$$

$$\Rightarrow 18 \times 7 - 25$$

$$126 - 25 = \boxed{101}$$

Same as,

$$15, 11, 30 = ?$$

$$\Rightarrow 15 \times 11 - 30$$

$$165 - 30 = \boxed{135}$$



335. In each of the given number-clusters, the number on the right side of '=' (the equal to sign) is calculated by performing certain mathematical operations on the three numbers on the left of '=' (the equal to sign). All three number-clusters follow the same pattern. Select the number from among the given options that can replace the question mark (?) in the third number-cluster.

$$4, 3, 2 = 21$$

$$5, 6, 3 = 52$$

$$5, 8, 4 = ?$$

$$(a) 41$$

$$(b) 85$$

$$(c) 73$$

$$(d) 106$$

RRB NTPC (Stage-II) –13/06/2022 (Shift-II)

Ans. (c) : Just as,

$$4, \quad 3, \quad 2 = 21$$

↓

$$(4)^2 + (3)^2 - (2)^2 = 21$$

and,

$$5, \quad 6, \quad 3 = 52$$

↓

$$(5)^2 + (6)^2 - (3)^2 = 52$$

Same as,

$$5, \quad 8, \quad 4 = ?$$

↓

$$(5)^2 + (8)^2 - (4)^2 = \boxed{73}$$

Hence, ? = 73

336. Select the set in which the numbers are related in the same way as are the numbers of the following sets.

(NOTE: Operations should be performed on the whole, without breaking down the numbers into its constituent digits. E.g. 13-Operations on 13 such as adding/subtracting/multiplying etc. to 13 can be performed. Breaking down 13 into 1 and 3 and then performing mathematical operations on 1 and 3 is not allowed.)

$$(3, 5, 21)$$

$$(4, 2, 14)$$

$$(a) (6, 3, 12)$$

$$(b) (8, 4, 28)$$

$$(c) (5, 2, 19)$$

$$(d) (7, 1, 23)$$

RRB Group-D– 29/08/2022 (Shift-III)

Ans.(b) : Just as,

$$(3, 5, 21)$$

$$(3 \times 2) + (5 \times 3) = 21$$

$$6 + 15 = 21$$

$$21 = 21$$

Similarly, from option (b)-

$$(8, 4, 28)$$

$$(8 \times 2) + (4 \times 3) = 28$$

$$16 + 12 = 28$$

$$28 = 28$$

and,

$$(4, 2, 14)$$

$$(4 \times 2) + (2 \times 3) = 14$$

$$8 + 6 = 14$$

$$14 = 14$$

337. Select the set in which the numbers are related in the same way as are the numbers of the following sets.

(NOTE : Operations should be performed on the whole numbers, without breaking down the numbers into its constituent digits. E.g. 13-Operations on 13 such as adding/subtracting/multiplying etc. to 13 can be performed. Breaking down 13 into 1 and 3 and then performing mathematical operations on 1 and 3 is not allowed)

$$(7, 150, 23)$$

$$(14, 100, 6)$$

$$(a) (15, 140, 13)$$

$$(b) (4, 108, 16)$$

$$(c) (8, 90, 11)$$

$$(d) (9, 80, 11)$$

RRB Group-D– 29/08/2022 (Shift-III)

Ans.(a) : Just as,

$$(7, 150, 23)$$

$$(7+23) \times 5 \Rightarrow 150$$

$$30 \times 5 \Rightarrow 150$$

$$150 = 150$$

Similarly, from option (a)-

$$(15, 140, 13)$$

$$(15+13) \times 5 \Rightarrow 140$$

$$28 \times 5 \Rightarrow 140$$

$$140 = 140.$$

and,

$$(14, 100, 6)$$

$$(14+6) \times 5 \Rightarrow 100$$

$$20 \times 5 \Rightarrow 100$$

$$100 = 100$$

338. Select the set in which the numbers are related in the same way as are the numbers of the following sets.

(NOTE : Operations should be performed on the whole numbers, without breaking down the numbers into its constituent digits. Eg. 13 – Operations on 13 such as adding / subtracting/multiplying etc. to 13 can be performed. Breaking down 13 into 1 and 3 and then performing mathematical operations on 1 and 3 is not allowed)

$$(20, 16, 8)$$

$$(13, 20, 23)$$

$$(a) (14, 18, 16)$$

$$(b) (32, 27, 18)$$

$$(c) (13, 16, 13)$$

$$(d) (19, 18, 21)$$

RRB Group-D– 08/09/2022 (Shift-III)

Ans. (b) : Such as,

$$(20, 16, 8) \rightarrow 16 \times 2 - (20 + 8) = 32 - 28 = 4$$

and,

$$(13, 20, 23) \rightarrow 20 \times 2 - (13 + 23) = 40 - 36 = 4$$

Similarly,

$$(32, 27, 18) \rightarrow 27 \times 2 - (32 + 18) = 54 - 50 = 4$$

Hence, the correct answer is option (b).

339. Select the set in which the numbers are related in the same way as are the numbers of the following sets.

(NOTE : Operations should be performed on the whole numbers, without breaking down the numbers into its constituent digits. Eg. 13 – Operations on 13 such as adding / subtracting / multiplying etc. to 13 can be performed. Breaking down 13 into 1 and 3 and then performing mathematical operations on 1 and 3 is not allowed)

(13, 9, 5)

(14, 11, 8)

(a) (18, 26, 36) (b) (22, 32, 24)

(c) (22, 19, 16) (d) (14, 10, 12)

RRB Group-D– 08/09/2022 (Shift-III)

Ans. (c) : Such as,

$$(13,9,5) \rightarrow (13+5) \div 2 = 9$$

and,

$$(14,11,8) \rightarrow (14+8) \div 2 = 11$$

Similarly,

$$(22,19,16) \rightarrow (22+16) \div 2 = 19$$

Hence, option (c) is correct answer.

340. Select the option that is related to the fifth number in the same way as the second number is related to the first number and the fourth number is related to the third number.

(NOTE : Operations should be performed on the whole numbers, without breaking down the numbers into its constituent digits. E.g. 13- Operations on 13 such as adding subtracting/multiplying etc. to 13 can be performed. Breaking down 13 into 1 and 3 and then performing mathematical operations on 1 and 3 is not allowed)

16 : 2 :: 36 : 3 :: 64 : ?

(a) 6 (b) 5

(c) 4 (d) 3

RRB Group-D– 29/08/2022 (Shift-II)

Ans.(c) : Just as,

$$16 : 2 \Rightarrow 2 \times 2 \times 4 \Rightarrow 16$$

and,

$$36 : 3 \Rightarrow 3 \times 3 \times 4 = 36$$

Same as,

$$64 : ? \Rightarrow 4 \times 4 \times 4 = 64$$

Hence,  $? = 4$

341. Select the set in which the numbers are related in the same way as are the numbers of the following sets.

(NOTE : Operations should be performed on the whole numbers, without breaking down the numbers into its constituent. E.g. 13- Operations on 13 such as adding/subtracting / multiplying etc. to 13 can be performed. Breaking down 13 into 1 and 3 and then performing mathematical operations on 1 and 3 is not allowed)

(14, 60, 16)

(25, 80, 15)

(a) (15, 45, 30) (b) (19, 80, 21)

(c) (20, 30, 40) (d) (21, 120, 15)

RRB Group-D– 29/08/2022 (Shift-II)

Ans.(b) : Just as,

(14, 60, 16)

↓

$$(14+16) \times 2 \Rightarrow 60$$

$$30 \times 2 \Rightarrow 60$$

Similarly, from option (b),

(19, 80, 21)

↓

$$(19 + 21) \times 2 \Rightarrow 80$$

$$40 \times 2 = 80$$

$$80 = 80$$

$$(LHS = RHS)$$

and,

(25, 80, 15)

↓

$$(25+15) \times 2 = 80$$

$$40 \times 2 = 80$$

342. Select the set in which the numbers are related in the same way as are the numbers of the following sets.

(NOTE: Operations should be performed on the whole numbers, without breaking down the numbers into its constituent digits. E.g. 13 - Operations on 13 such as adding/subtracting/ multiplying etc. to 13 can be performed. Breaking down 13 into 1 and 3 and then performing mathematical operations on 1 and 3 is not allowed.)

(7, 19, 40)

(12, 11, 47)

(a) (14, 23, 74) (b) (9, 27, 72)

(c) (15, 31, 48) (d) (16, 5, 53)

RRB Group-D– 26/08/2022 (Shift-I)

Ans. (d) : Such as,

$$(7,19,40) \rightarrow (40-19) \div 3=7$$

and ,

$$(12,11,47) \rightarrow (47-11) \div 3=12$$

Similarly, from option (d)-

$$(16,5,53) \rightarrow (53-5) \div 3= 16$$

Hence, option (d) is correct answer.

343. Select the option in which the numbers are related in the same way as are the numbers of the following sets.

(NOTE: Operations should be performed on the whole numbers, without breaking down the numbers into its constituent digits. E.g. 13 - Operations on 13 such as adding/Subtracting/ multiplying etc. to 13 can be performed. Breaking down 13 into 1 and 3 and then performing mathematical operations on 1 and 3 is not allowed)

(85, 198, 52)

(77, 270, 32)

(a) (61, 90, 47) (b) (62, 90, 47)

(c) (62, 94, 47) (d) (62, 90, 45)

RRB Group-D– 26/08/2022 (Shift-I)

Ans. (b) : Such as,

$$(85,198,52) \rightarrow (85-52) \times 6 = 198$$

and,

$$(77,270,32) \rightarrow (77-32) \times 6 = 270$$



Similarly, from option (b)-

$$(62,90,47) \rightarrow (62-47) \times 6 = 90$$

Hence, option (b) is correct answer.

344. Select the set in which the numbers are related in the same way as are the numbers of the following sets.

(NOTE: Operations should be performed on the whole numbers, without breaking down the numbers into its constituent digits. E.g. 13 - Operations on 13 such as adding/Subtracting/multiplying etc. to 13 can be performed. Breaking down 13 into 1 and 3 and then performing mathematical operations on 1 and 3 is not allowed)

(22, 49, 568)

(25, 45, 560)

(a) (30, 15, 225) (b) (15, 33, 240)

(c) (18, 27, 225) (d) (33, 38, 568)

RRB Group-D- 30/09/2022 (Shift-I)

Ans. (d) : Such as,

$$(22,49,568) \rightarrow (22+49) \times 8 = 568$$

and,

$$(25,45,560) \rightarrow (25+45) \times 8 = 560$$

Similarly, from option (d),

$$(33,38,568) \rightarrow (33+38) \times 8 = 568$$

Hence, option (d) is correct answer.

345. Select the set in which the numbers are related in the same way as are the numbers of the following sets.

(NOTE: Operations should be performed on the whole numbers, without breaking down the numbers into its constituent digits. E.g. 13 - Operations on 13 such as adding/subtracting/multiplying etc. to 13 can be performed. Breaking down 13 into 1 and 3 and then performing mathematical operations on 1 and 3 is not allowed.)

(13, 84, 8)

(21, 136, 13)

(a) (27, 140, 8) (b) (16, 23, 156)

(c) (14, 56, 8) (d) (8, 71, 19)

RRB Group-D- 26/08/2022 (Shift-III)

Ans. (a) : Such as,

$$(13,84,8) \rightarrow (13+8) \times 4 = 84$$

and,

$$(21,136,13) \rightarrow (21+13) \times 4 = 136$$

Similarly, from option (d),

$$(27,140,8) \rightarrow (27+8) \times 4 = 140$$

Hence, option (d) is correct answer.

346. Select the set in which the numbers are related in the same way as are the numbers of the following sets.

(NOTE : Operations should be performed on the whole numbers, without breaking down the numbers into its constituent digits. Eg. 13 - Operations on 13 such as adding / Subtracting/ multiplying etc. to 13 can be performed. Breaking down 13 into 1 and 3 and then performing mathematical operations on 1 and 3 is not allowed)

(4, 24)

(11, 143)

(a) (9, 102)

(b) (7, 42)

(c) (5, 40)

(d) (2, 8)

RRB Group-D- 08/09/2022 (Shift-II)

Ans. (d) : Such as,

$$(4,24) \rightarrow (4)^2 + 4 \times 2 = 24$$

and,

$$(11,143) \rightarrow (11)^2 + 11 \times 2 = 143$$

Similarly,

$$(2,8) \rightarrow (2)^2 + 2 \times 2 = 8$$

Hence, option (d) is correct answer.

347. Select the set in which the numbers are related in the same way as are the numbers of the following sets. (NOTE: Operations should be performed on the whole numbers, without breaking down the numbers into its constituent digits. E.g. 13 - Operations on 13 such as adding/ subtracting multiplying etc. to 13 can be performed. Breaking down 13 into 1 and 3 and then performing mathematical operations on 1 and 3 is not allowed)

(10, 300, 10)

(11, 165, 5)

(a) (8, 20, 8)

(b) (11, 188, 6)

(c) (10, 400, 20)

(d) (9, 243, 9)

RRB Group-D- 15/09/2022 (Shift-III)

Ans. (d) : Such as,

$$(10,300,10) \rightarrow 10 \times 10 \times 3 = 300$$

and,

$$(11,165,5) \rightarrow 11 \times 5 \times 3 = 165$$

Similarly, from option (d)-

$$(9,243,9) \rightarrow 9 \times 9 \times 3 = 243$$

Hence, option (d) is correct answer.

348. Select the set in which the numbers are related in the same way as are the numbers of the following sets.

(NOTE : Operations should be performed on the whole numbers, without breaking down the numbers into its constituent digits. Eg. 13 Operations on 13 such as adding / subtracting/ multiplying etc. to 13 can be performed. Breaking down 13 into 1 and 3 and then performing mathematical operations on 1 and 3 is not allowed.)

- (75, 16, 67)  
 (33, 14, 26)  
 (a) (88, 54, 76) (b) (28, 72, 64)  
 (c) (40, 56, 96) (d) (29, 6, 26)

RRB Group-D- 06/10/2022 (Shift-III)

**Ans. (d) :** Such as,  
 $(75, 16, 67) \rightarrow (75-67) \times 2 = 8 \times 2 = 16$   
 and,  
 $(33, 14, 26) \rightarrow (33-26) \times 2 = 7 \times 2 = 14$   
 Similarly,  
 $(29, 6, 26) \rightarrow (29-26) \times 2 = 3 \times 2 = 6$   
 Hence, option (d) is correct answer.

349. Select the option that is related to the fifth number in the same way as the second number is related to the first number and the fourth number is related to the third number.

- 6 : 33 :: 11 : 58 :: 18 : ?  
 (a) 150 (b) 105  
 (c) 98 (d) 93

RRB Group-D- 26/08/2022 (Shift-III)

**Ans. (d) :** Just as,  
 $6 : 33 \Rightarrow 6 \times 5 + 3 = 33$   
 and,  
 $11 : 58 \Rightarrow 11 \times 5 + 3 = 58$   
 Similarly,  
 $18 : ? \Rightarrow 18 \times 5 + 3 = 93$   
 Hence,  $? = 93$

350. Select the set in which the numbers are related in the same way as are the numbers of the following sets.

(NOTE : Operations should be performed on the whole numbers, without breaking down the numbers into its constituent digits, E.g. 13- Operations on 13 such as adding / subtracting / multiplying etc. to 13 can be performed. Breaking down 13 into 1 and 3 and then performing mathematical operations on 1 and 3 is not allowed)

- (15, 41, 4)  
 (19, 71, 5)  
 (a) (41, 125, 4) (b) (13, 55, 3)  
 (c) (44, 91, 3) (d) (10, 8, 2)

RRB Group-D- 17/08/2022 (Shift-I)

**Ans. (d) :** Just as,  
 $(15, 41, 4) \Rightarrow \frac{15+41}{(15-1)} = \frac{56}{14} = 4$  (Last term)  
 and,  
 $(19, 71, 5) \Rightarrow \frac{19+71}{(19-1)} = \frac{90}{18} = 5$  (Last term)  
 Similarly,  
 $(10, 8, 2) \Rightarrow \frac{10+8}{(10-1)} = \frac{18}{9} = 2$  (Last term)

351. Select the option that is related to the fifth number in the same way as the second number is related to the first number and the fourth number is related to the third number :

- 10 : 55 :: 12 : 65 :: 18 : ?  
 (a) 85 (b) 92  
 (c) 90 (d) 95

RRB Group-D- 17/08/2022 (Shift-I)

**Ans. (d) :** Given, series is as follows,  
 $10 : 55 :: 12 : 65 :: 18 : ? = 95$   
 $(10 \times 5 + 5) \quad (12 \times 5 + 5) \quad (18 \times 5 + 5)$

352. Select the option that is related to the fifth number in the same way as the second number is related to the number, the fourth number is related to the third number.

- 15 : 2 :: 255 : 4 :: 624 : ?  
 (a) 3 (b) 9  
 (c) 8 (d) 5

RRB Group-D- 16/09/2022 (Shift-II)

**Ans. (d) :** Just as,  $15 : 2$  And,  $255 : 4$   
 $2^4 - 1 \quad 4^4 - 1$   
 Same as,  
 $624 : ? = 5$   
 $5^5 - 1$   
 Hence,  $? = 5$

353. Select the set in which the numbers are selected in the same way as are the numbers of the following sets.

(NOTE: Operations should be performed on the whole numbers, without breaking down the numbers into its constituent digits. E.g. 13- Operations on 13 such as adding / subtracting / multiplying etc. to 13 can be performed. Breaking down 13 into 1 and 3 and then performing mathematical operations on 1 and 3 is not allowed)

- (14, 336, 8)  
 (12, 324, 9)  
 (a) (18, 378, 7) (b) (18, 368, 7)  
 (c) (18, 398, 7) (d) (18, 478, 7)

RRB Group-D- 16/09/2022 (Shift-II)

**Ans. (a) :** Just as,  $(14, 336, 8)$  and,  $(12, 324, 9)$   
 $\downarrow \quad \downarrow$   
 $(14 \times 8) \times 3 = 336 \quad (12 \times 9) \times 3 = 324$   
 $112 \times 3 = 336 \quad 108 \times 3 = 324$   
 $336 = 336 \quad 324 = 324$   
 Same as, from option (a)-  
 $(18, 378, 7)$   
 $\downarrow$   
 $(18 \times 7) \times 3 = 378$   
 $126 \times 3 = 378$   
 $378 = 378$



354. Select the option in which the number are related in the same way as are the numbers of the given sets.

(NOTE : Operations should be performed on the whole numbers without breaking down the numbers into its constituent digits.

E.g. 13-Operations on 13 such as adding/ subtracting / multiplying etc. to 13 can be performed. Breaking down 13 into 1 and 3 and then performing mathematical operations on 1 and 3 is not allowed)

(2, 42, 4)

(7, 57, 5)

(a) (5, 57, 7)

(b) (3, 83, 8)

(c) (1, 19, 9)

(d) (8, 46, 4)

RRB Group-D- 13/09/2022 (Shift-I)

Ans. (b) : Just as,

$$(2, 42, 4) \Rightarrow 2, \overset{\curvearrowright}{\underset{\curvearrowleft}{42}}, 4$$

and,

$$(7, 57, 5) \Rightarrow 7, \overset{\curvearrowright}{\underset{\curvearrowleft}{57}}, 5$$

Similarly -

$$(3, 83, 8) \Rightarrow (3, \overset{\curvearrowright}{\underset{\curvearrowleft}{83}}, 8)$$

355. Select the set in which the number are related in the same way as are the numbers of the following sets.

(NOTE : Operations should be performed on the whole numbers, without breaking down the numbers into its constituent digits E.g. 13-Operations on 13 such as adding / subtracting / multiplying etc. to 13 can be performed. Breaking down 13 into 1 and 3 and then performing mathematical operation on 1 and 3 is not allowed)

(13, 182, 91)

(17, 306, 153)

(a) 15, 200, 50

(b) 9, 125, 50

(c) 8, 72, 36

(d) 11, 154, 67

RRB Group-D- 01/09/2022 (Shift-II)

Ans. (c) : Just as,

(13, 182, 91)

and, (17, 306, 153)

Same as (8, 72, 36)

$$13 \times (13+1) = 182$$

$$17 \times (17+1) = 306$$

$$8 \times (8+1) = 72$$

$$182 \times \frac{1}{2} = 91$$

$$306 \times \frac{1}{2} = 153$$

$$72 \times \frac{1}{2} = 36$$

356. Select the option that is related to the fifth number in the same way as the second is related to the first number and the fourth number is related to the third number.

8 : 19 :: 5 : 13 :: 7 : ?

(a) 15

(b) 19

(c) 17

(d) 21

RRB Group-D- 01/09/2022 (Shift-II)

Ans. (c) : Given series is as follows,

$$\begin{array}{ccccc} 8 & 19 & 5 & 13 & 7 & 17 \\ \downarrow & \uparrow & \downarrow & \uparrow & \downarrow & \uparrow \\ & \times 2 + 3 & & \times 2 + 3 & & \times 2 + 3 \end{array}$$

Hence,  $?\ = 17$

357. Select the set in which the number are related are related in the same way as are the numbers of the following sets.

(NOTE : Operations should be performed on the whole numbers, without breaking down the number into its constituent digits. E. g. 13-Operations on 13 such as adding / subtracting / multiplying etc to 13 can be performed. Breaking down 13 into 1 and 3 and then performing mathematical operations on 1 and 3 is not allowed)

(12, 15, 18)

(45, 35, 25)

(a) (14, 28, 14)

(b) (19, 18, 1)

(c) (13, 10, 17)

(d) (15, 20, 25)

RRB Group-D- 17/08/2022 (Shift-II)

Ans. (d) : Just as,

$$\Rightarrow \frac{12+18}{2} = 15 \text{ (mid term)}$$

and,

$$\Rightarrow \frac{45+25}{2} = 35 \text{ (mid term)}$$

Same as from option (d)-

$$\frac{15+25}{2} = 20 \text{ (mid term)}$$

Hence, option (d) is correct.

358. Select the set in which the numbers are related in the same way as are the numbers of the following sets.

(NOTE : Operations should be performed on the whole numbers, without breaking down the numbers into its constituent digits. E.g. 13-Operations on 13 such as adding / subtracting / multiplying etc. to 13 can be performed. Breaking down 13 into 1 and 3 and then performing mathematical operations on 1 and 3 is not allowed)

(35, 12, 29)

(23, 16, 31)

(a) (18, 12, 21)

(b) (19, 8, 23)

(c) (21, 25, 29)

(d) (33, 30, 27)

RRB Group-D- 17/08/2022 (Shift-II)

Ans. (b) : According to the question :

Given,

$$(35, 12, 29) = (35 - 29) \Rightarrow 6 \times \boxed{2} = 12$$

and,

$$(23, 16, 31) \Rightarrow (31 - 23) \Rightarrow 8 \times \boxed{2} = 16$$

From option (b),

$$(19, 8, 23) \Rightarrow (23 - 19) \Rightarrow 4 \times \boxed{2} = 8$$

Hence, option (b) is correct.

359. Select the set in which the numbers are related in the same way as are the numbers of the following sets.

(NOTE : Operations should be performed on the whole numbers, without breaking down the numbers into its constituent digits. E.g. 13-Operations on 13 such as adding/ subtracting/multiplying etc. to 13 can be performed. Breaking down 13 into 1 and 3 and then performing mathematical operations on 1 and 3 is not allowed)

(13, 84, 29)

(27, 122, 34)

(a) (17, 45, 13)

(b) (15, 57, 27)

(c) (25, 90, 20)

(d) (10, 56, 23)

Ans. (c) : Just as,

$$(13, 84, 29) \Rightarrow (13 + 29) \times 2 = 84$$

and,

$$(27, 122, 34) \Rightarrow (27 + 34) \times 2 = 122$$

Similarly,

$$(25, 90, 20) \Rightarrow (25 + 20) \times 2 = 90$$

Hence, option (c) is correct.

360. Select the option that is related to the fifth number in the same way as the second number is related to the first number and the fourth number is related to the third number.

8 : 127 :: 5 : 49 :: 1 : ?

(a) 214

(b) 203

(c) 103

(d) 241

Ans. (d) : Just as,

$$8 : 127 \rightarrow (8)^2 \times 2 - 1 = 127$$

and,

$$5 : 49 \rightarrow (5)^2 \times 2 - 1 = 49$$

Similarly

$$11 : ? \rightarrow (11)^2 \times 2 - 1 = 241$$

Hence  $? = 241$

361. Select the option that is related to the third term in the same way as the second term is related to the first term and the sixth term is related to the fifth term.

48 : 16 :: 96 : ? :: 108 : 21

(a) 22

(b) 21

(c) 20

(d) 23

RRB Group-D- 06/10/2022 (Shift-I)

Ans.(c) : Just as,

$$\begin{array}{cc} 48 & : & 16 \\ \swarrow \searrow & & \downarrow \\ (12 \times 4) & & (12 + 4) \end{array}$$

Same as,

$$\begin{array}{cc} 96 & : & ? \\ \swarrow \searrow & & \downarrow \\ (12 \times 8) & & (12 + 8) \end{array}$$

Hence,  $? = 12 + 8 = 20$

Analogy

362. Select the set in which the numbers are related in the same way as are the numbers of the following sets.

(NOTE : Operations should be performed on the whole numbers, without breaking down the numbers into its constituent digits. E.g. 13 – Operations on 13 such as adding / subtracting / multiplying etc. to 13 can be performed. Breaking down 13 into 1 and 3 and then performing mathematical operations on 1 and 3 is not allowed)

(4, 11, 31)

(3, 9, 25)

(a) (7, 11, 35)

(b) (2, 8, 19)

(c) (5, 13, 29)

(d) (6, 15, 43)

RRB Group-D- 06/10/2022 (Shift-I)

Ans.(d) : Just as,

$$(4, 11, 31)$$

and,

$$(3, 9, 25)$$

$$(4+11) \times 2 + 1 = 31$$

$$(3+9) \times 2 + 1 = 25$$

$$15 \times 2 + 1 = 31$$

$$12 \times 2 + 1 = 25$$

Same as, from option (d),

$$(6, 15, 43)$$

$$(6+15) \times 2 + 1 = 43$$

$$21 \times 2 + 1 = 43$$

Hence, option (d) is correct.

363. Select the set in which the numbers are related in the same way as are the numbers of the following sets.

(NOTE: Operations should be performed on the whole numbers, without breaking down the numbers into its constituent digits. E.g. 13-Operations on 13 such as adding/ subtracting / multiplying etc. to 13 can be performed. Breaking down 13 into 1 and 3 and then performing mathematical operations on 1 and 3 is not allowed)

(10, 150, 3)

(8, 80, 2)

(a) (18, 270, 3)

(b) (12, 197, 4)

(c) (11, 188, 6)

(d) (10, 401, 9)

RRB Group-D- 26/09/2022 (Shift-II)

Ans.(a) : Just as,

$$(10, 150, 3) \Rightarrow 10 \times 3 \times 5 = 150$$

and,

$$(8, 80, 2) \Rightarrow 8 \times 2 \times 5 = 80$$

Similarly,

$$(18, 270, 3) \Rightarrow 18 \times 3 \times 5 = 270$$

Hence, option (a) is correct.

364. Select the set in which the numbers are related in the same way as are the numbers of the following sets. (NOTE: Operations should be performed on the whole numbers, without breaking down the numbers into its constituent digits. E.g. 13-Operations on 13 such as adding/ subtracting/multiplying etc. to 13 can be performed. Breaking down 13 into 1 and 3 and then performing mathematical operations on 1 and 3 is not allowed.)



- (13, 16, 21)  
 (28, 34, 45)  
 (a) (72, 45, 27) (b) (35, 12, 59)  
 (c) (37, 18, 46) (d) (64, 26, 90)

**RRB Group-D- 26/09/2022 (Shift-II)**

**Ans.(c) :** Just as,  
 $(13, 16, 21) \Rightarrow (21 - 13) \times 2 = 16$   
 and,  
 $(28, 34, 45) \Rightarrow (45 - 28) \times 2 = 34$   
 Similarly,  
 $(37, 18, 46) \Rightarrow (46 - 37) \times 2 = 18$   
 Hence option (c) is correct answer.

**365. Select the option in which the numbers share the same relationship as that shared by the given pair of numbers.**

- 11 : 132**  
 (a) 6 : 48 (b) 9 : 93  
 (c) 8 : 72 (d) 7 : 61

**RRB NTPC 30.12.2020 (Shift-II) Stage Ist**

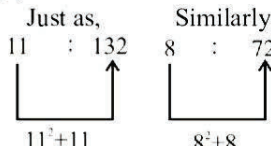
**Ans. (c) :**  
 Just as,  $11 : 132$  Similarly,  $8 : 72$   
  
 $11^2 + 11$        $8^2 + 8$   
 Hence, option (c) is correct.

**366. Select the option that is related to the third number in the same way as the second number is related to the first number :**

- 343 : 1331 : 729 : ?**  
 (a) 2187 (b) 2197  
 (c) 2184 (d) 2211

**RRB NTPC 10.01.2021 (Shift-I) Stage Ist**

**Ans. (b) :** Just as,  $343 : 1331$  Similarly,  $729 : 2197$   
  
 $(7)^3$        $(11)^3$        $(9)^3$        $(13)^3$   
 +4      +4

**367. Select the option that is related to the third number in the same way as the second number is related to the first number.**

- 9 : 729 = 11 : ?**  
 (a) 1024 (b) 112  
 (c) 1331 (d) 991

**RRB NTPC 11.01.2021 (Shift-I) Stage Ist**

**Ans. (c) :** Just as,  
 $(9)^3 \rightarrow 729$   
 Same as,  
 $(11)^3 \rightarrow 1331$

**368. Select the option that is related to the third number in the same way as the first number is related to the second number.**

- 14 : 210 :: 16 : ?**

- (a) 272 (b) 240  
 (c) 212 (d) 256

**RRB NTPC 16.01.2021 (Shift-I) Stage Ist**

**Ans. (b) :** As,  
 $14 : 210 :: 16 : ?$   
 $\frac{210}{14} = 15$   
 Same as,  
 $\frac{?}{16} = 15 \Rightarrow ?$   
 $= 16 \times 15 = 240$

**369. Select the number from among the options given that is related to the third number in the same way as the second number is related to the first number.**

- 3 : 28 :: 9 : ?**  
 (a) 81 (b) 80  
 (c) 729 (d) 730

**RRB NTPC 18.01.2021 (Shift-I) Stage Ist**

**Ans. (d) :** Just as,,  
 $3 : 28$   
 $\downarrow$   
 $(3)^3 + 1 = 28$   
 Similarly,  
 $9 : ?$   
 $\downarrow$   
 $(9)^3 + 1 = 729 + 1$   
 $= 730$   
 Therefore,  $? = 730$

**370. Select the number from among the options given that is related to the fifth number in the same way as the second and fourth numbers are related to the first and third numbers respectively**

- 11 : 143 :: 13 : 221 :: 7 : ?**  
 (a) 35 (b) 56  
 (c) 57 (d) 77

**RRB NTPC 16.02.2021 (Shift-II) Stage Ist**

**Ans. (d) :** On multiplying into 11 to its next prime number -

$11 \times 13 = 143$   
 Similarly, on multiplying into 13 to its next prime number =  $13 \times 17 = 221$

Same as, on multiplying into 7 to its next prime number =  $7 \times 11 = 77$

$11 : 143 :: 13 : 221 :: 7 : 77$

Hence,  $? = 77$

**371. Which of the given number triads has some relationship between them as does 6, 42, 336?**

- (a) 7, 21, 106 (b) 9, 6, 224  
 (c) 4, 28, 224 (d) 2, 4, 642

**RRB NTPC 05.03.2021 (Shift-I) Stage Ist**

**Ans. (c) :** Just as,  
 $6 \quad 42 \quad 336$   
 $\downarrow \quad \downarrow \quad \downarrow$   
 $\times 7 \quad \times 8$   
 Same as,  
 $4 \quad 28 \quad 224$   
 $\downarrow \quad \downarrow \quad \downarrow$   
 $\times 7 \quad \times 8$   
 Hence, option (c) is correct.

**372. Select the option in which the numbers are related in the same way as are the numbers in the given sets**

- (343, 36, 13), (64, 16, 8), (27, 25, 8)  
 (a) (28, 25, 8) (b) (81, 27, 12)  
 (c) (216, 64, 14) (d) (63, 37, 14)

**RRB NTPC 08.03.2021 (Shift-II) Stage Ist**

**Ans. (c) :** In the given number sets-  
 Just as,  
 $(343, 36, 13) \rightarrow [(7)^3, (6)^2, 13] \rightarrow 7 + 6 = 13$   
 $(64, 16, 8) \rightarrow [(4)^3, (4)^2, 8] \rightarrow 4 + 4 = 8$   
 $(27, 25, 8) \rightarrow [(3)^3, (5)^2, 8] \rightarrow 3 + 5 = 8$   
 Similarly, in the set of numbers given in option (c)  
 $(216, 64, 14) \rightarrow [(6)^3, (8)^2, 14] \rightarrow 6 + 8 = 14$   
 Hence, option (c) is the corresponding set of numbers given in the question.

**373. Select the option that is related to the third number in the same way as the second number is related to the first number.**

- $2 : 32 :: 4 : ?$   
 (a) 728 (b) 128  
 (c) 1536 (d) 1024

**RRB NTPC 21.01.2021 (Shift-I) Stage Ist**

**Ans. (d) :**  
 Just as, Same as,  
 $2 : 32 \quad 4 : ?$   
 $(2)^5 = 32 \quad (4)^5 = 1024$

**374. Select the option that is related to the fifth number in the same way as the fourth number is related to the third number and in the same as the second number is related to the first number.**

- $6 : 34 :: 8 : 62 :: 9 : ?$   
 (a) 79 (b) 64  
 (c) 81 (d) 18

**RRB NTPC 10.02.2021 (Shift-II) Stage Ist**

**Ans. (a) :** From question,  
 $6 : 34 :: 8 : 62 :: 9 : ?$  79  
 $\downarrow \quad \downarrow \quad \downarrow$   
 $(6)^2 - 2 \quad (8)^2 - 2 \quad (9)^2 - 2$

**375. Select the option that is related to the third number in the same way as the second number is related to the first number.**

- $4704 : 336 :: 2590 : ?$   
 (a) 188 (b) 185  
 (c) 158 (d) 180

**RRB NTPC 27.02.2021 (Shift-I) Stage Ist**

**Ans. (b) :** Just as,  $\frac{4704}{336} = 14$   
 Similarly,  $\frac{2590}{?} = 14$   
 $\frac{2590}{14} = ?$   
 Hence, ? = 185

**376. Select the option in which the numbers are related in the same way as the numbers are in the given set.**

- 4, 20, 28**  
 (a) 6, 24, 48 (b) 8, 32, 64  
 (c) 2, 18, 24 (d) 12, 60, 84

**RRB NTPC 18.01.2021 (Shift-II) Stage Ist**

**Ans. (d) :** Just as,  
 $4 \quad 20 \quad 28$   
 $\downarrow \quad \downarrow \quad \downarrow$   
 $\times 5 \quad \times 7$   
 Similarly,  
 $12 \quad 60 \quad 84$   
 $\downarrow \quad \downarrow \quad \downarrow$   
 $\times 5 \quad \times 7$

**377. Select the number from the given options, that has the same relation to the fifth number as the second and fourth numbers have with the first and third numbers respectively.**

- $15 : 1365 :: 27 : 2817 :: 43 : ?$   
 (a) 3489 (b) 4893  
 (c) 4123 (d) 4493

**RRB NTPC 25.01.2021 (Shift-II) Stage Ist**

**Ans. (d) :** Just as,  
 $1 \quad 5 \quad 1 \quad 36 \quad 5 \quad (1+5)^2$   
 $\downarrow \quad \downarrow \quad \downarrow \quad \downarrow \quad \downarrow$   
 and  
 $2 \quad 7 \quad 2 \quad 81 \quad 7 \quad (2+7)^2$   
 $\downarrow \quad \downarrow \quad \downarrow \quad \downarrow \quad \downarrow$   
 Similarly,  
 $4 \quad 3 \quad 4 \quad 49 \quad 3 \quad (4+3)^2$   
 Hence, option (d) is correct.

**378. Select the option that is related to the third number in the same way as the second number is related to the first number.**

- $15 : 8 :: 25 : ?$   
 (a) 10 (b) 16  
 (c) 12 (d) 14

**RRB NTPC 14.03.2021 (Shift-II) Stage Ist**

**Ans. (a) :** Just as,  
 $15 : 8$   
 $15 \Rightarrow 15 \div 3 + 3 = 8$   
 Similarly,  
 $25 : ?$   
 $25 \Rightarrow 25 \div 5 + 5 = 10$   
 Therefore option (a) is correct.